

WATER WALL

Installation Instructions

**creative
play**

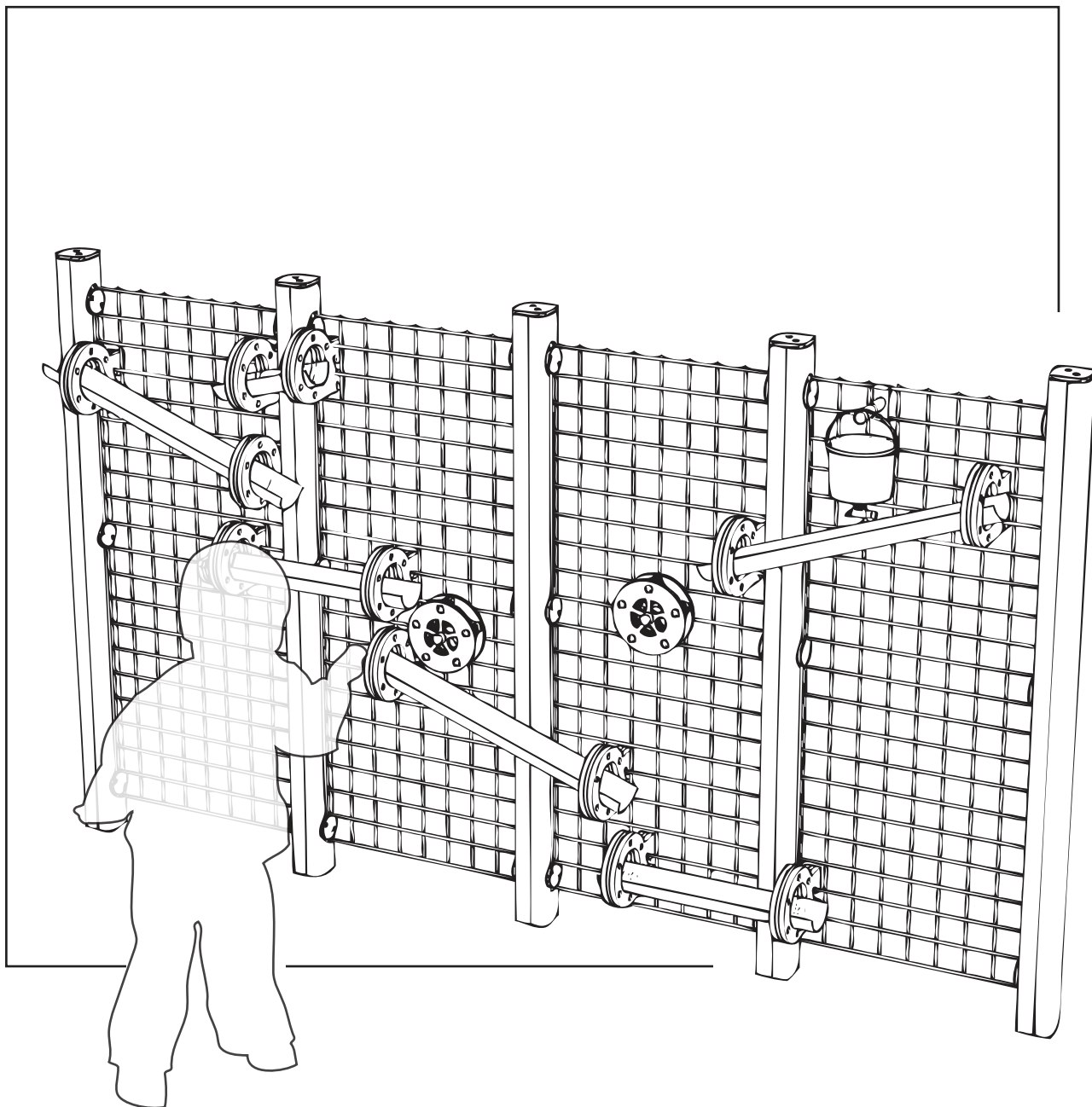

PARTS required

WATER CHANNELS

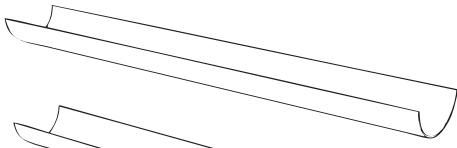

QTY x 4
HALF 112ø @ 800mm

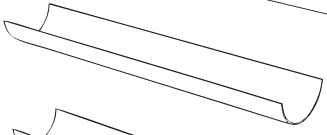

QTY x 5
HALF 112ø @ 600mm

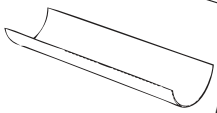

QTY x 5
HALF 112ø @ 400mm

CLEAR PLASTIC TUBE

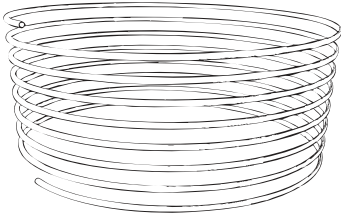

QTY x 2
190 @ 600mm

QTY x 2
190 @ 800mm

QTY x 2
190 @ 1000mm

BUCKET WITH VALVE

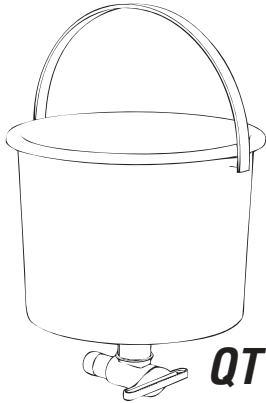

QTY x 2



PLASTIC BOX
QTY x 1

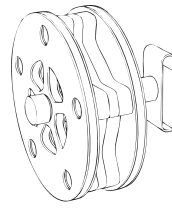

WATERWHEEL
QTY x 1 LEFT
QTY x 1 RIGHT

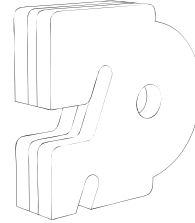

P - HOOK
QTY x 6

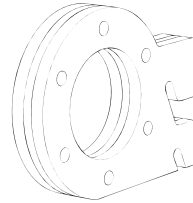

O - HOOK
QTY x 28

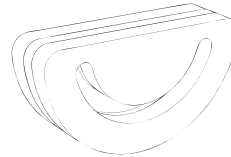

D - HOOK
QTY x 4



ATTACHEMENT CLIPS
QTY x 24

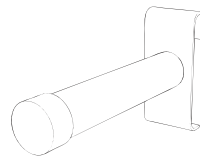

HANGER
QTY x 2

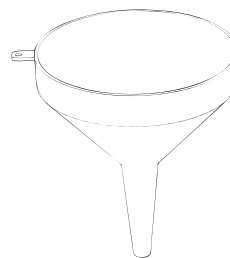

FUNNEL 5in
QTY x 3

PARTS required

GRID WALL MESH

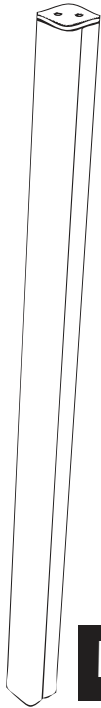

WSP7

QTY x 5

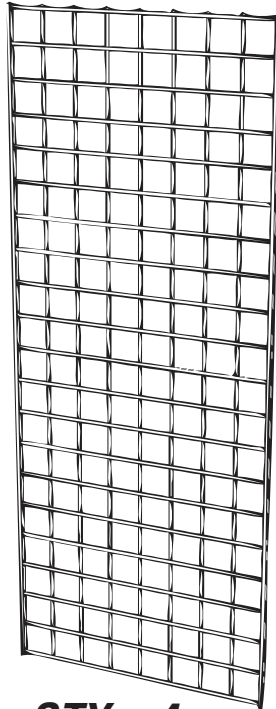

QTY x 4



x48 (FM80 'Brass screws')

TOOLS required

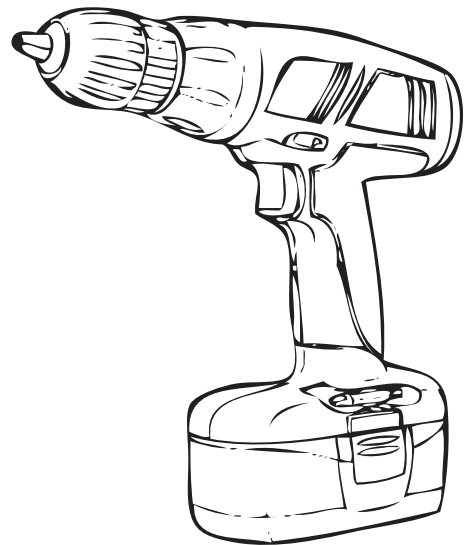
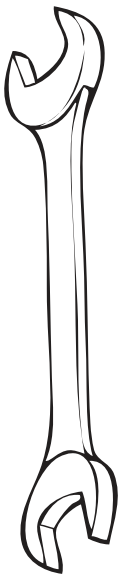

Foundation Details

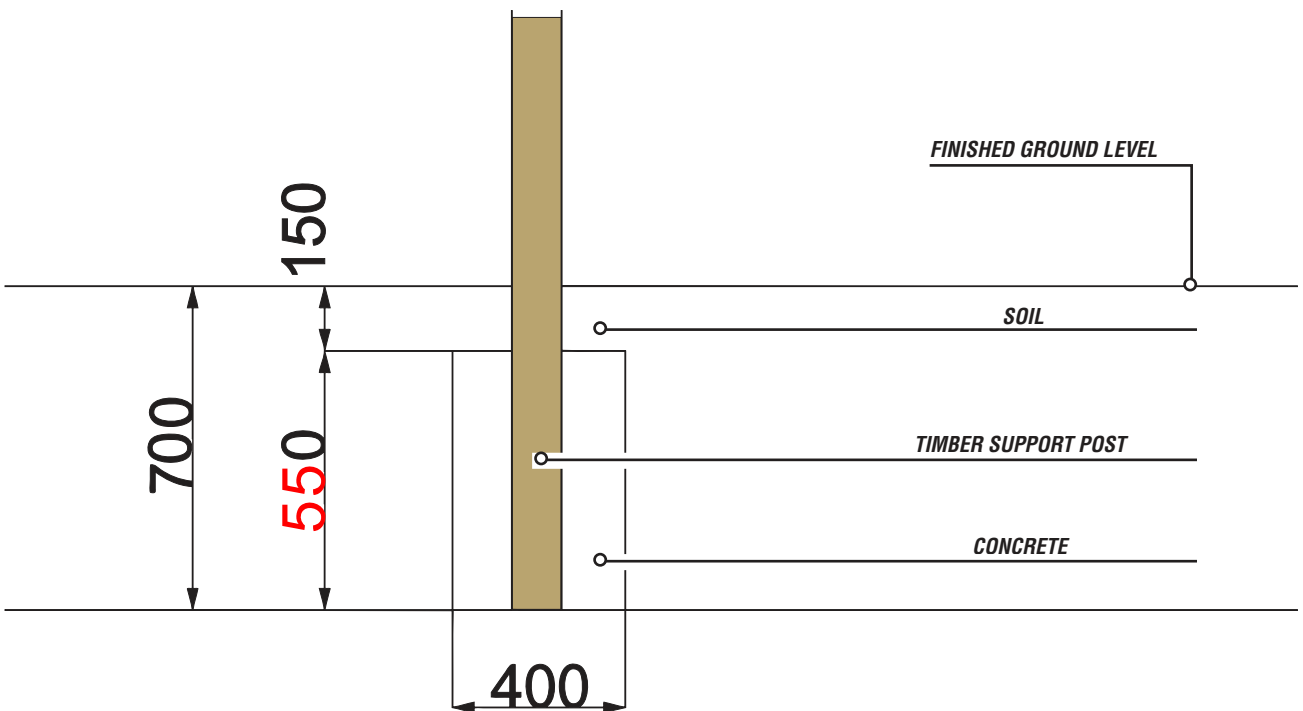
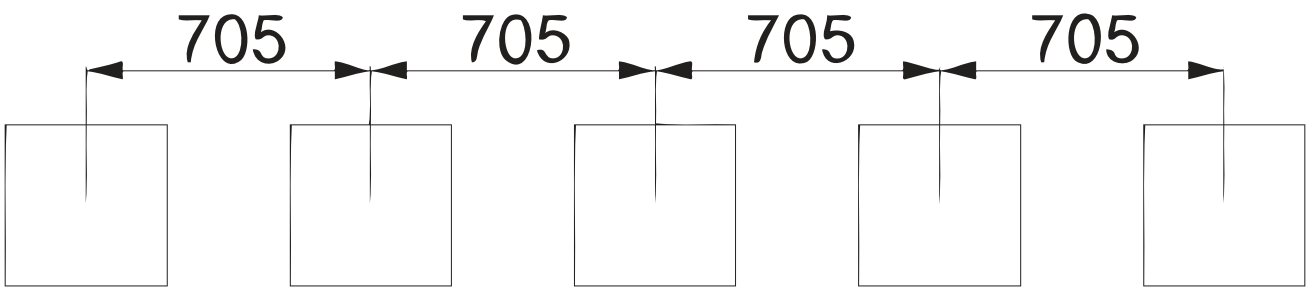

Surfacing Details

- - - = MINIMUM SPACE
- = SURFACE AREA

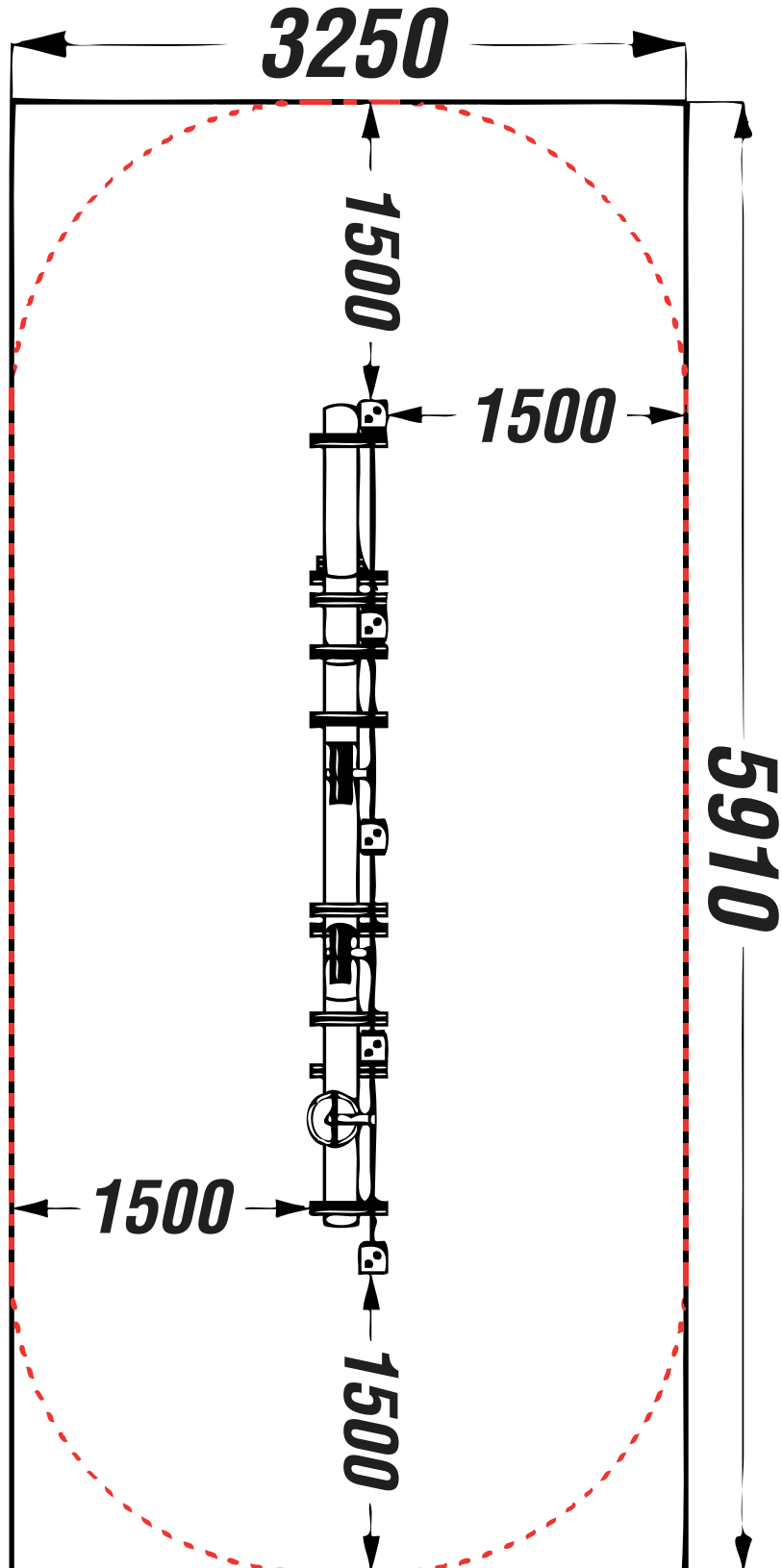

Installation Instructions

1

Attach the GRID WALL MESH to the timbers

Using 'BRASS SCREWS' and Attachment CLIPS

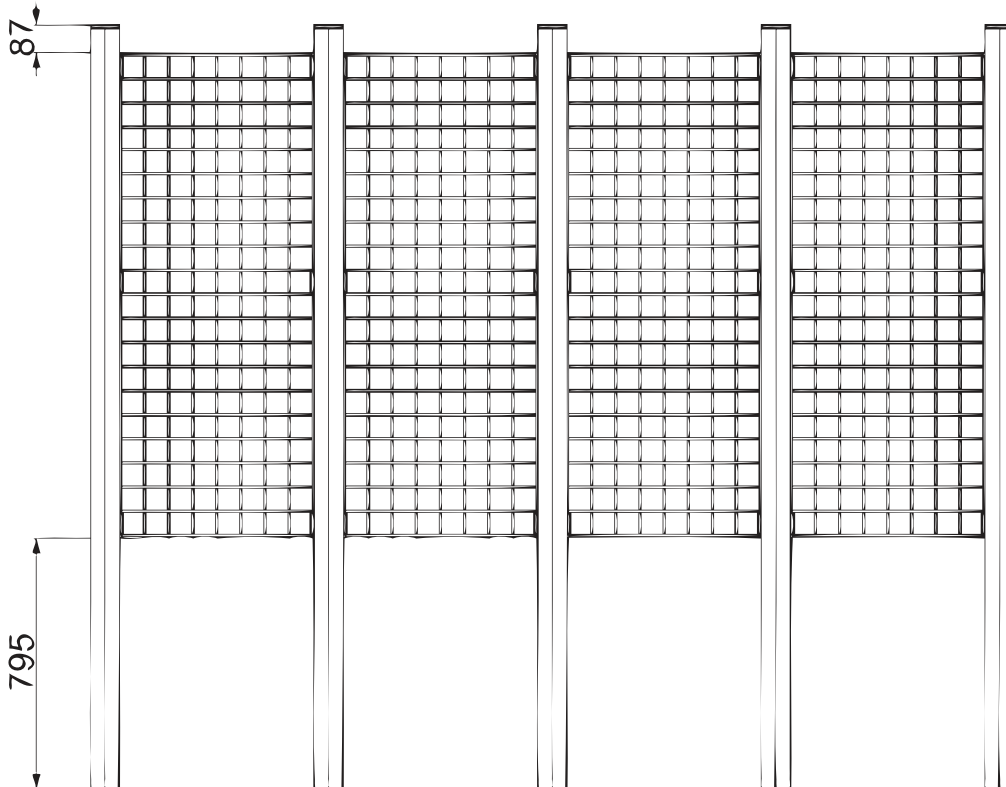
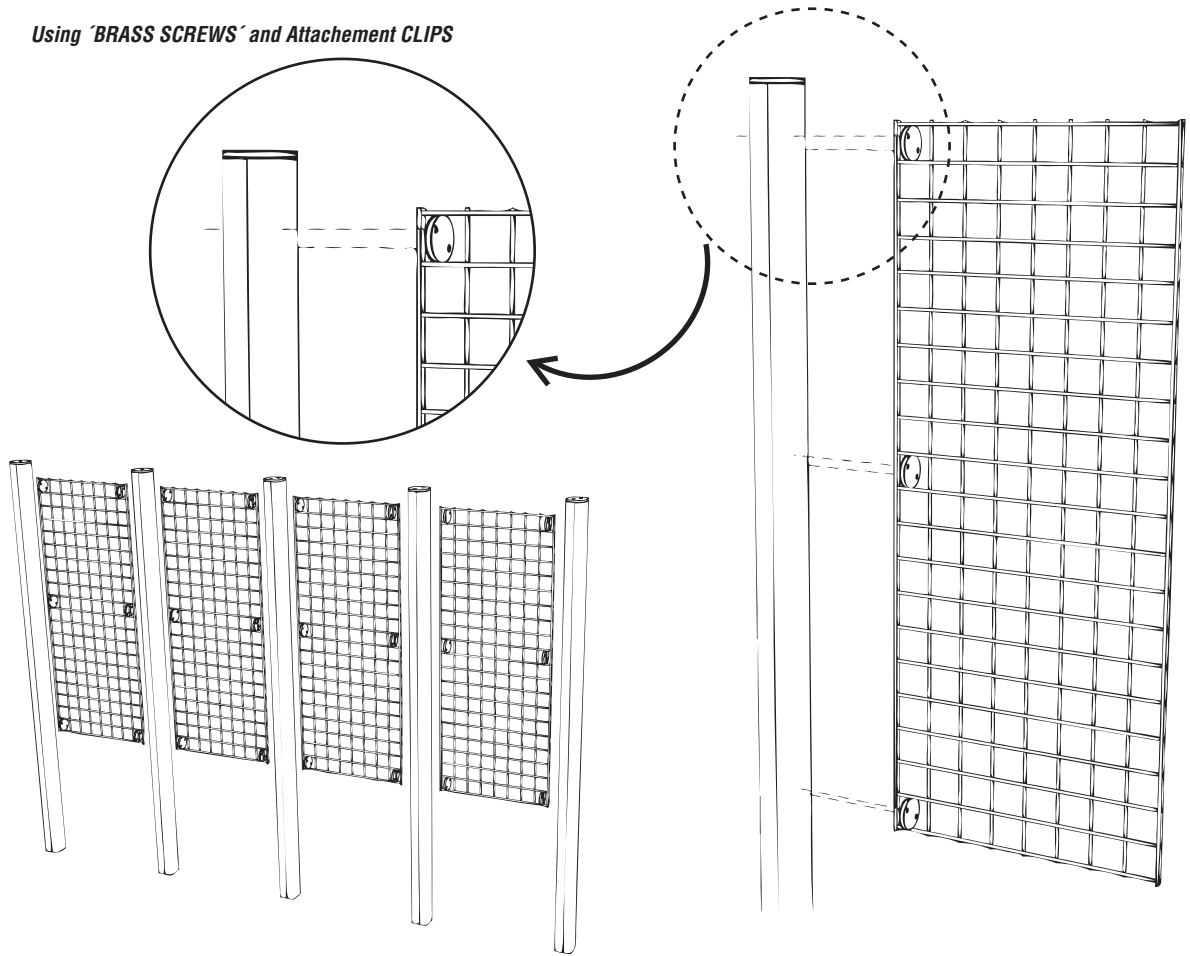

Additional Dimensions

