

PT107-A - 1.8M PICNIC TABLE (INSTALLED)

Installation Instructions

**creative
play**

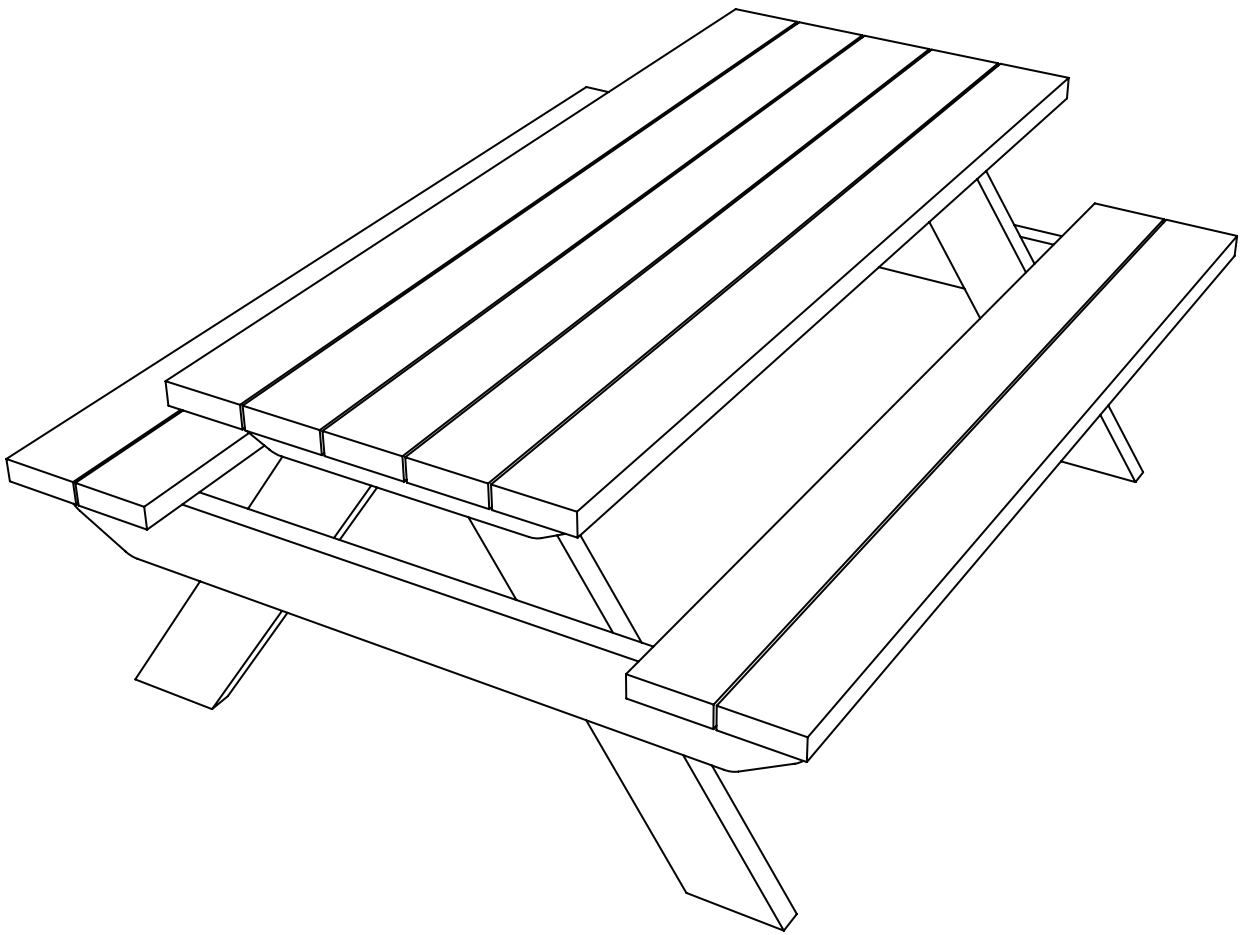

PT107-A - 1.8M PICNIC TABLE (INSTALLED)

Installation Instructions

creative
play

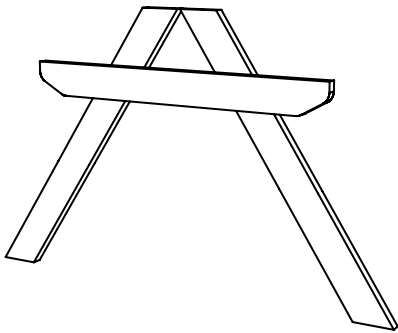

x2

TABLE LEGS

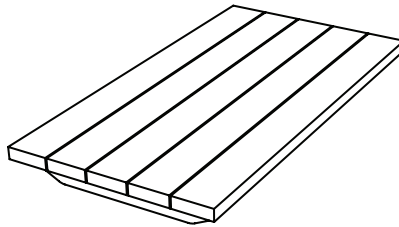

x1

1.8M TABLE TOP



x4

SEAT TIMBERS

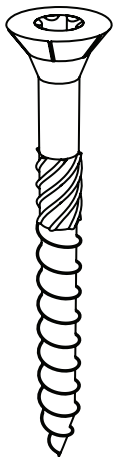

x24

M8X80CSK

TOOLS REQUIRED

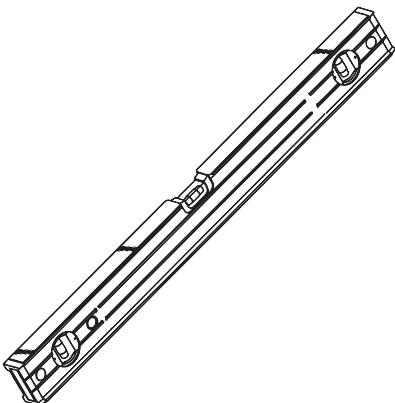

FOUNDATION DETAILS

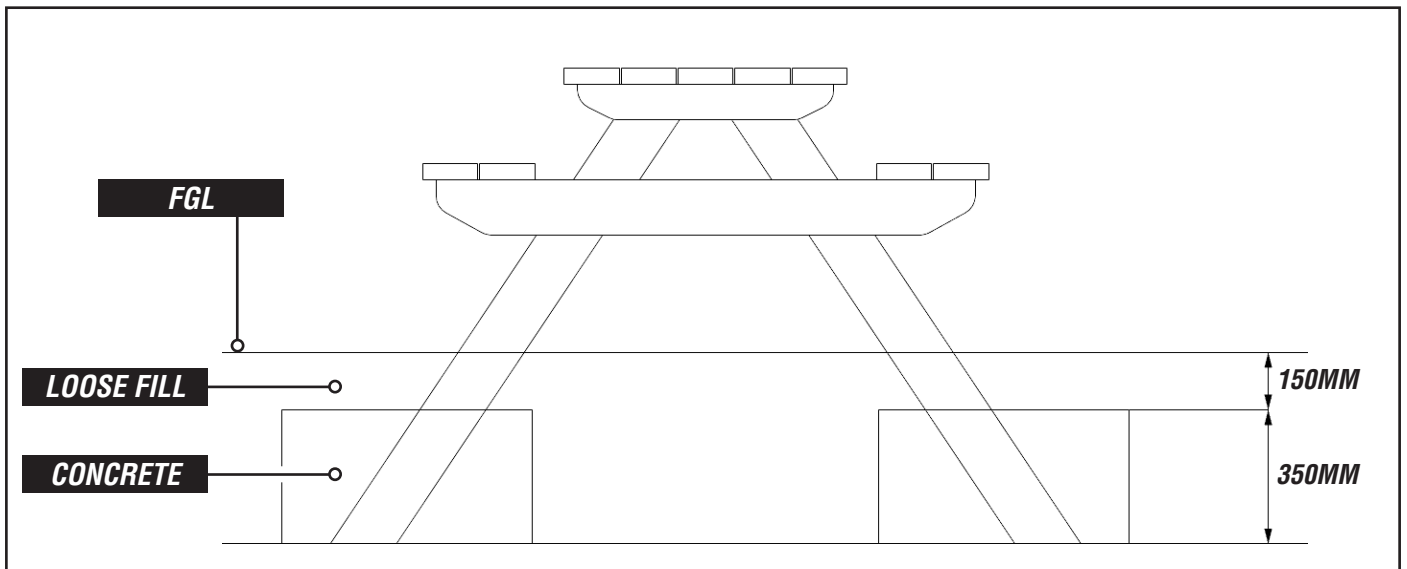
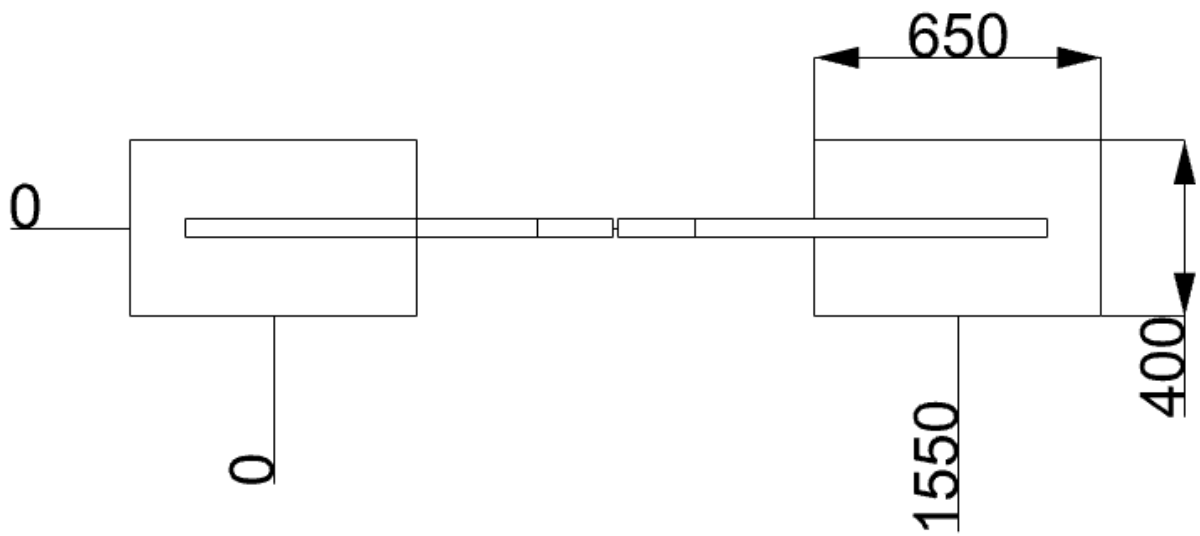
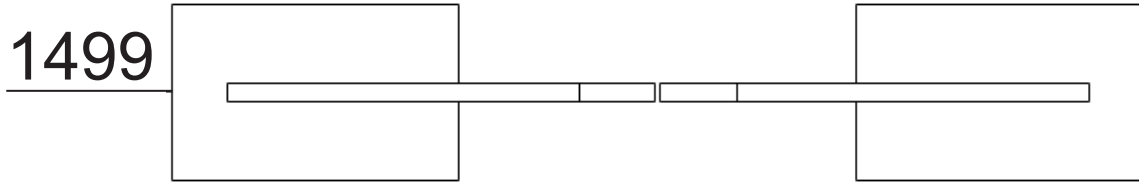

INSTALLATION INSTRUCTIONS

1

FIX TABLE TOP TO TABLE LEGS

USING M8X80 SCREWS [X8] - ENSURE LEGS SIT ON THE INSIDE OF THE TABLE TOP SUPPORTS

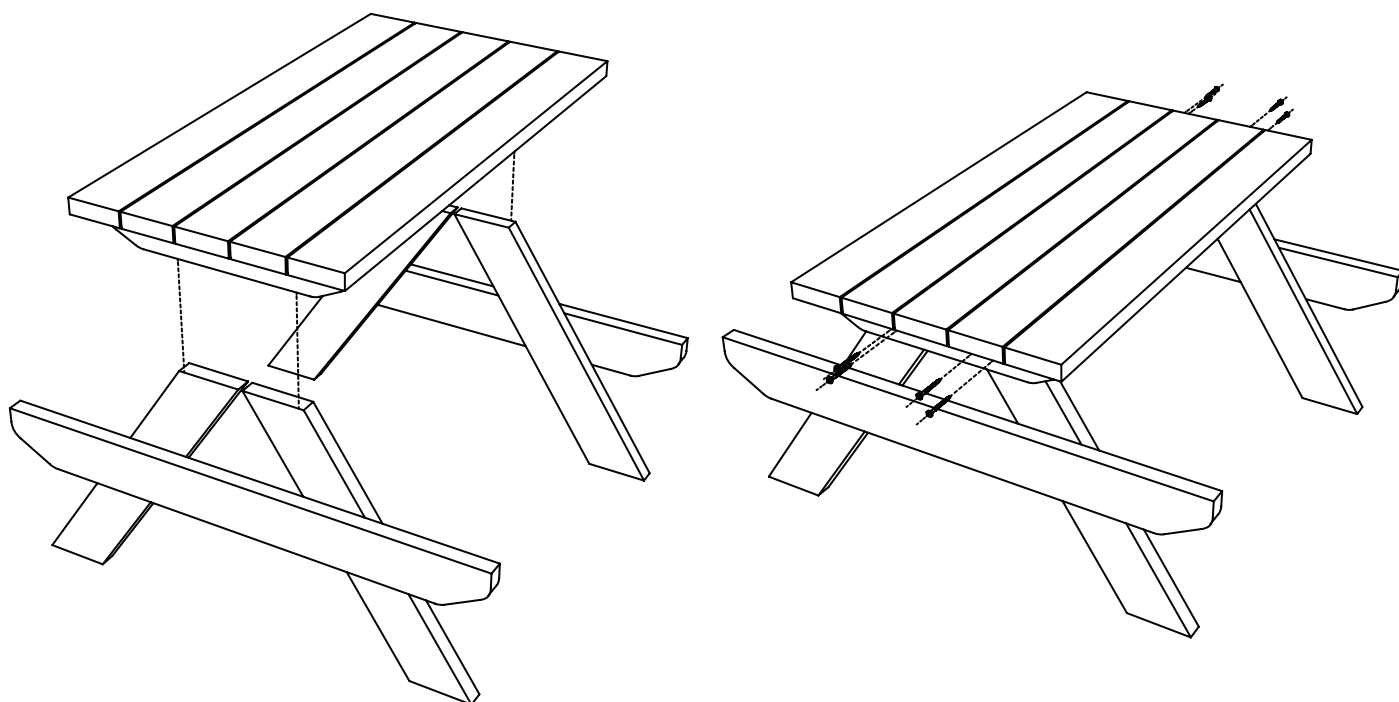

2

FIX SEATING TIMBERS TO TABLE TOP

USING M8X80 SCREWS [X16]

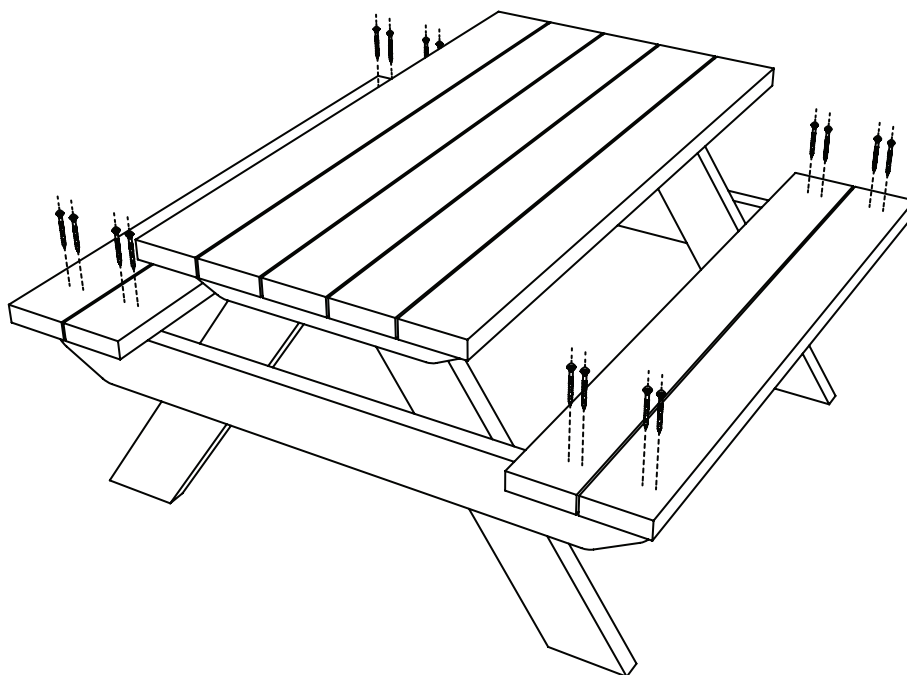

INSTALLATION INSTRUCTIONS

3

SECURE INTO THE GROUND
USING FOUNDATION DETAILS ON PAGE 3

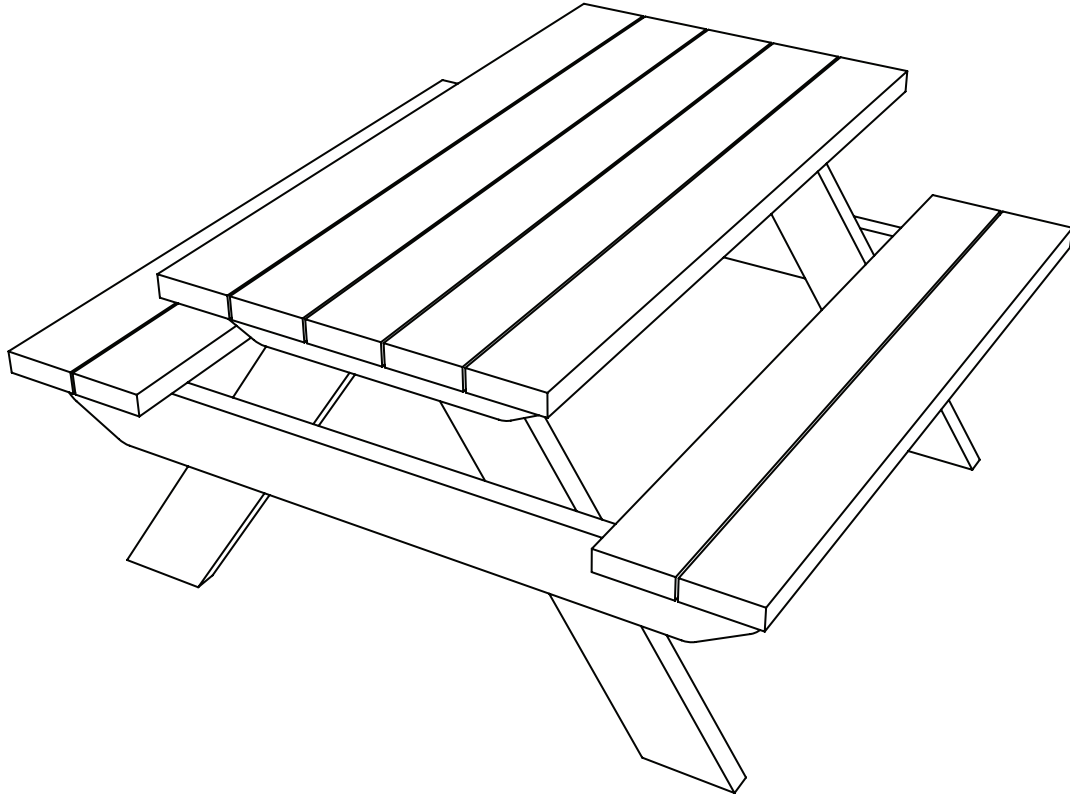

ADDITIONAL DIMENSIONS

