

PHONICS PLAY BOARD

Assembly Instructions

creative
play

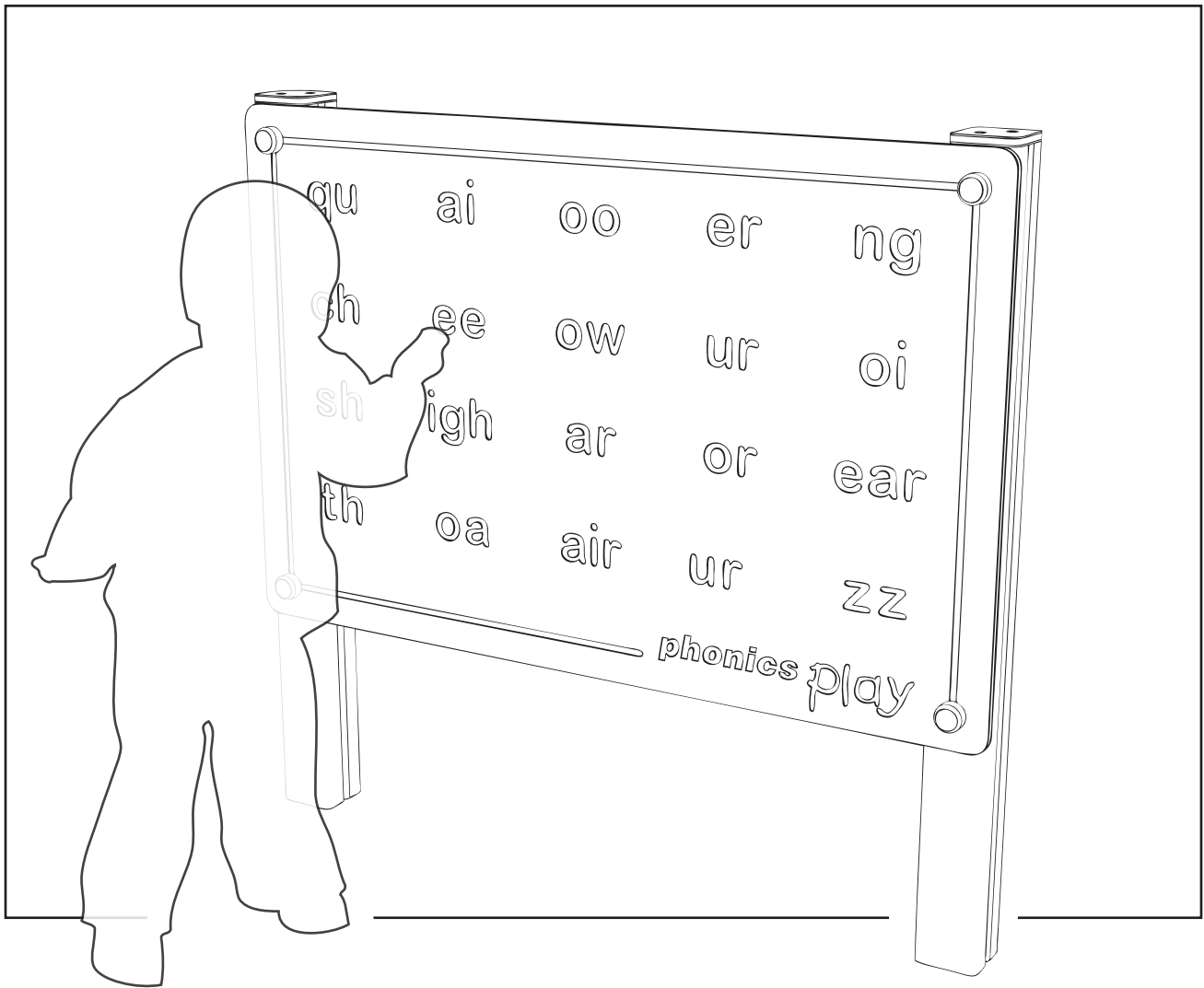

PARTS required

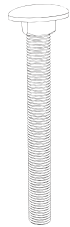

X4 (M12 120 cup square hex)



X4 (M12 Nylocs)



X4 (End Caps)

T1 QTY x 2
(90mm x 90mm)

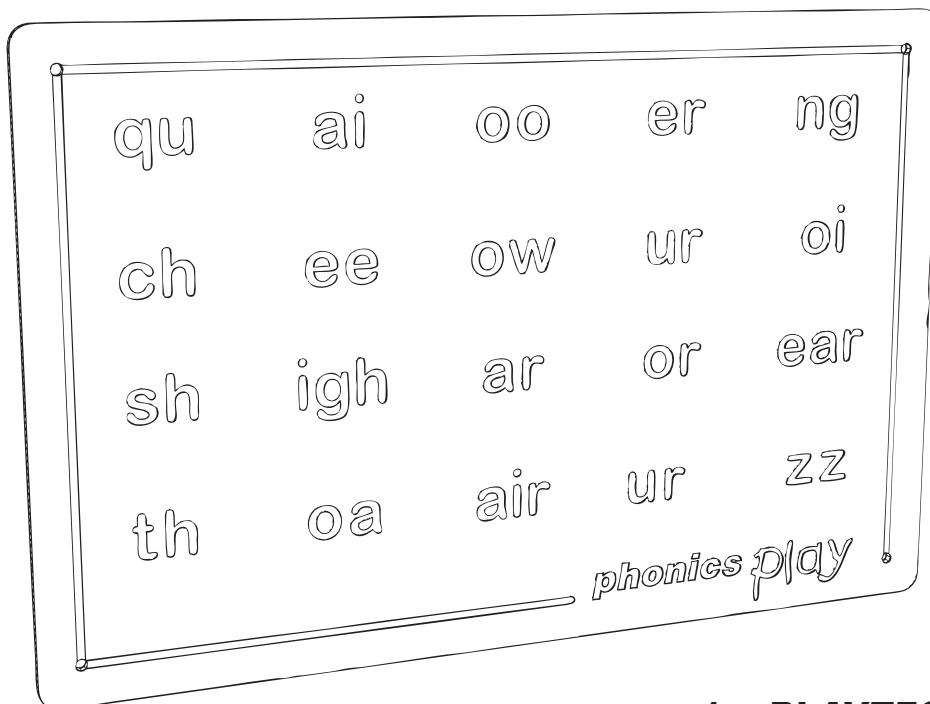
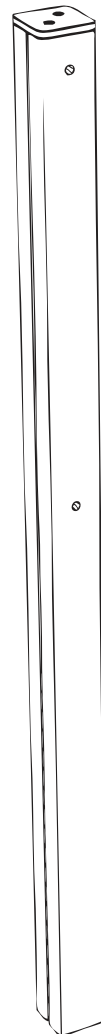

1 x PLAYTEC PANEL

Foundation Details

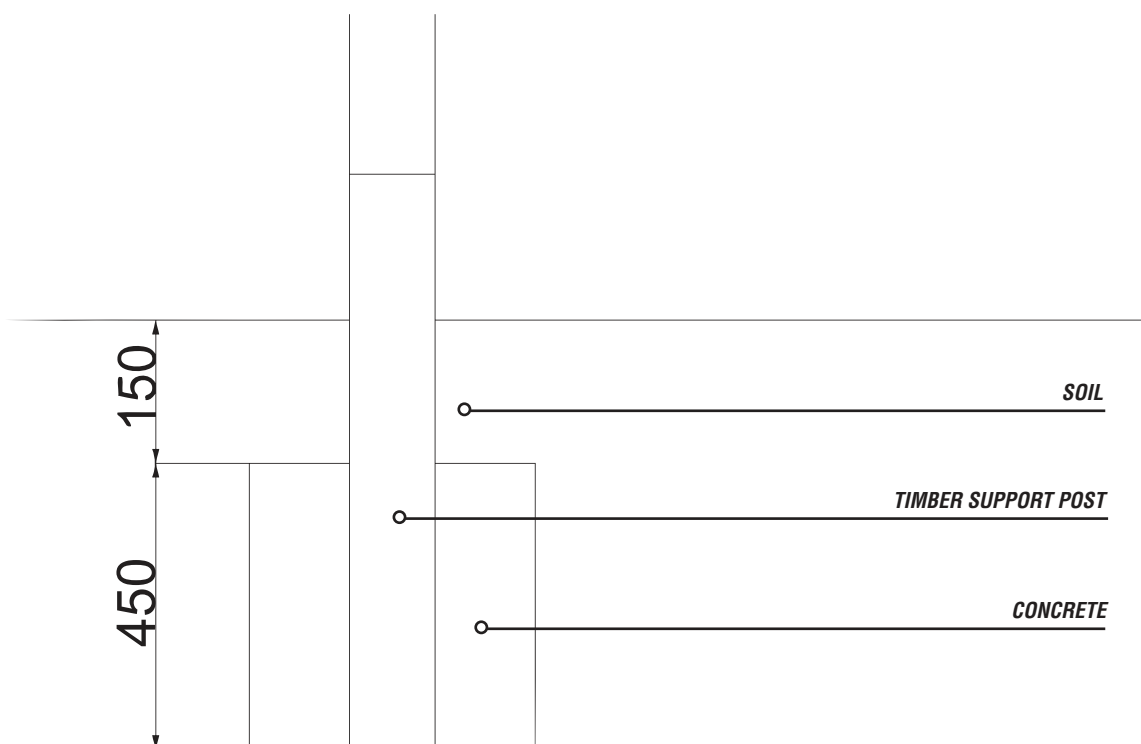
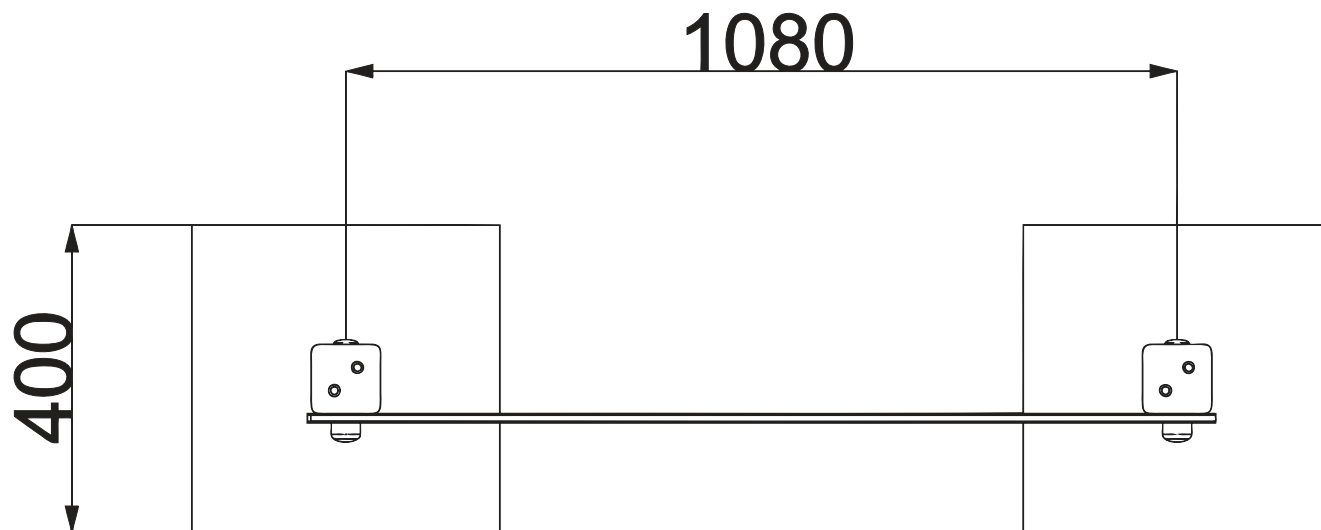

Assembly Instructions

1

Attach the PLAYTEC to the T1 timbers

Using M12 CUP SQUARE BOLTS / NYLOCS / END CAPS

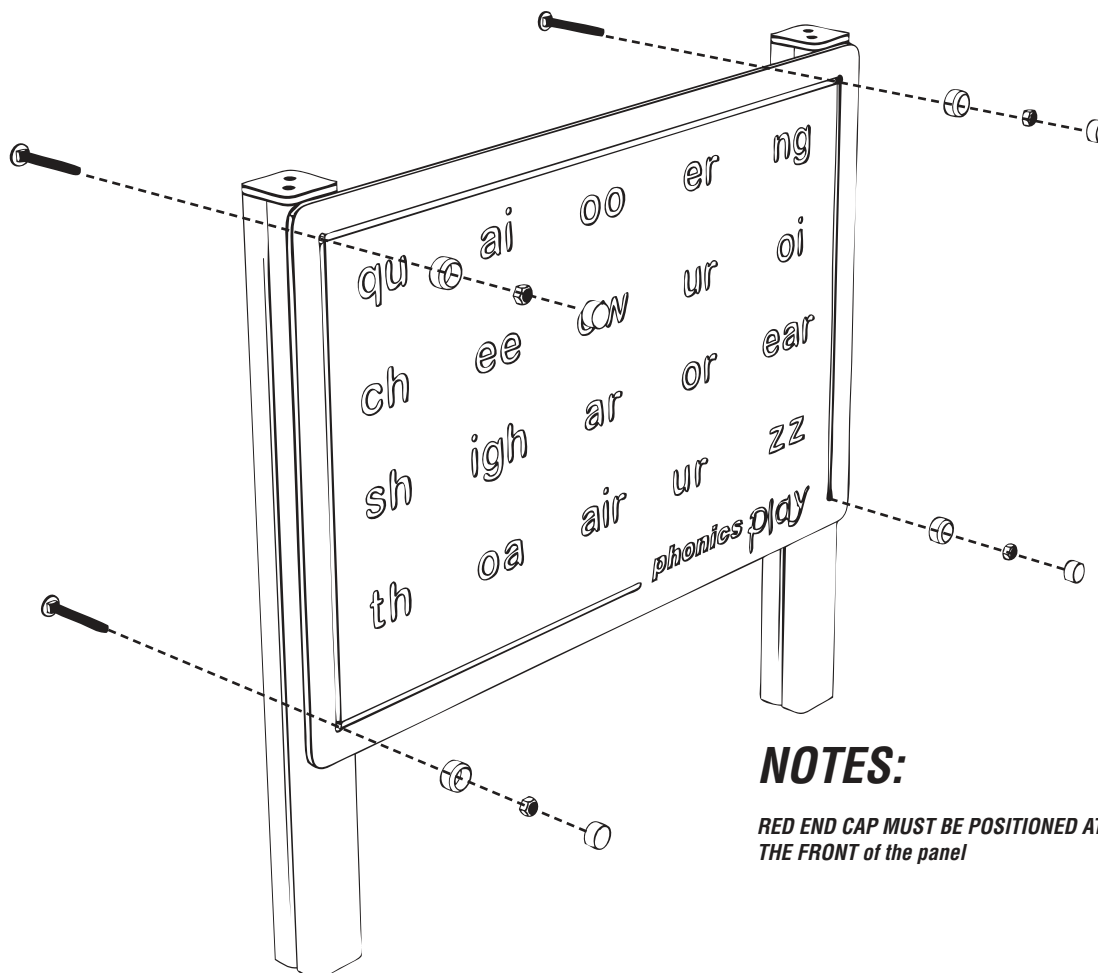

NOTES:

RED END CAP MUST BE POSITIONED AT THE FRONT of the panel