

CHIMES

Installation Instructions

creative
play

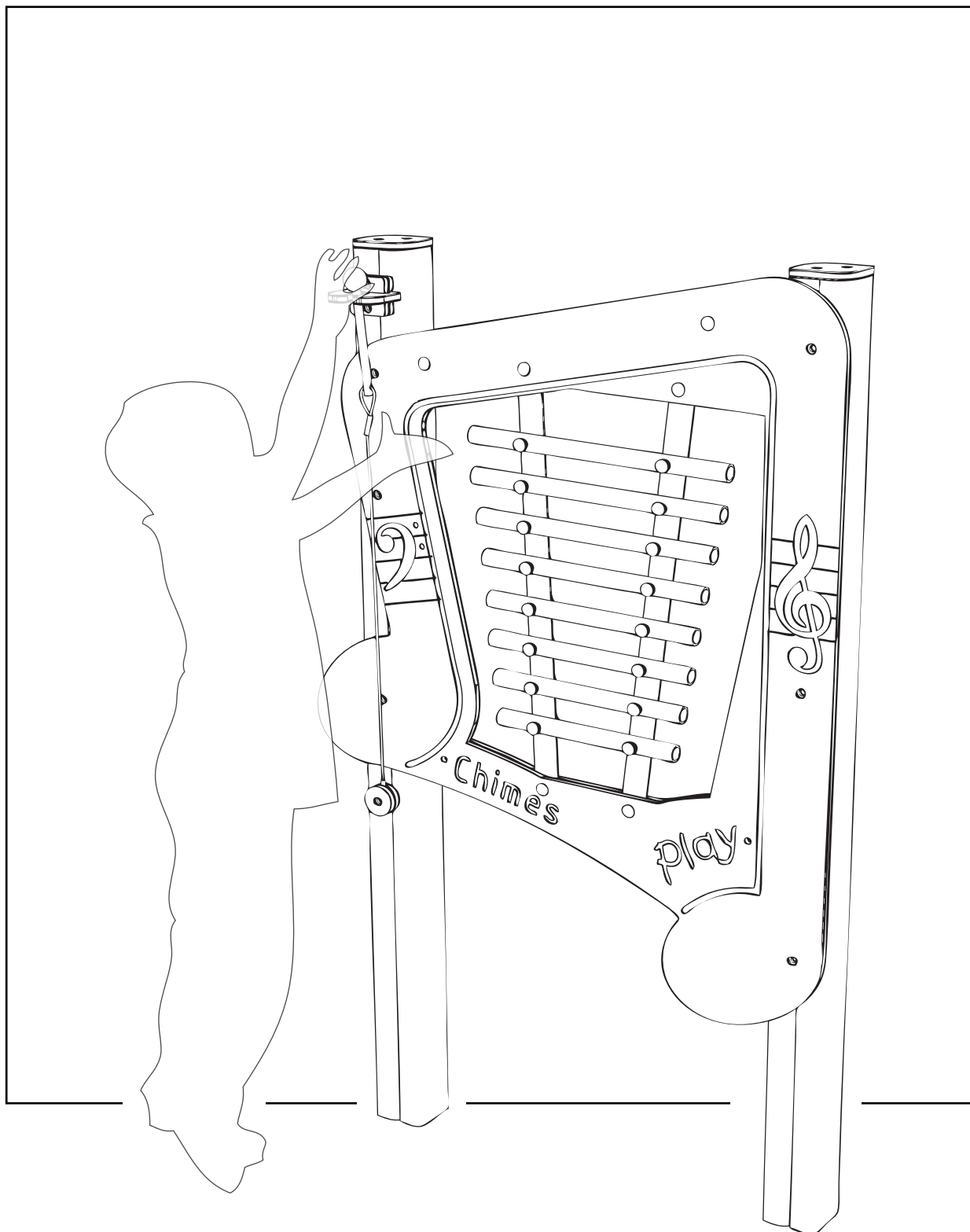

PARTS required

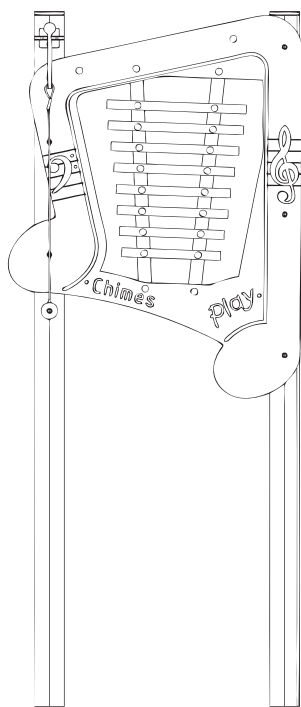

x1 PRE-ASSEMBLED MUSIC PLAY BOARD



x3 FM80 BRASS WOOD SCREWS



x1 PLAYTEC RING



x1 RECESSED PLAYTEC CIRCLE

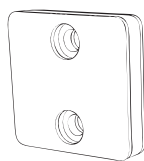

x1 PLAYTEC BLOCK

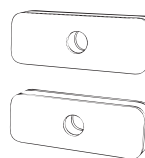

x2 OBLONG PLAYTEC PIECES

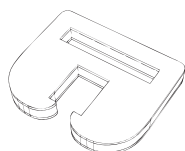

x1 PLAYTEC BEATER HOLDER



x1 BEATER WITH STEEL CORD

TOOLS required

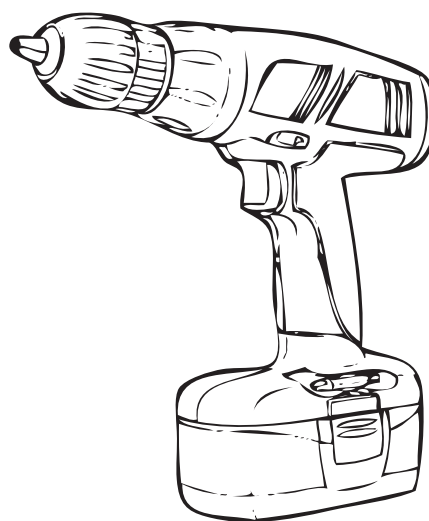

Foundation Details

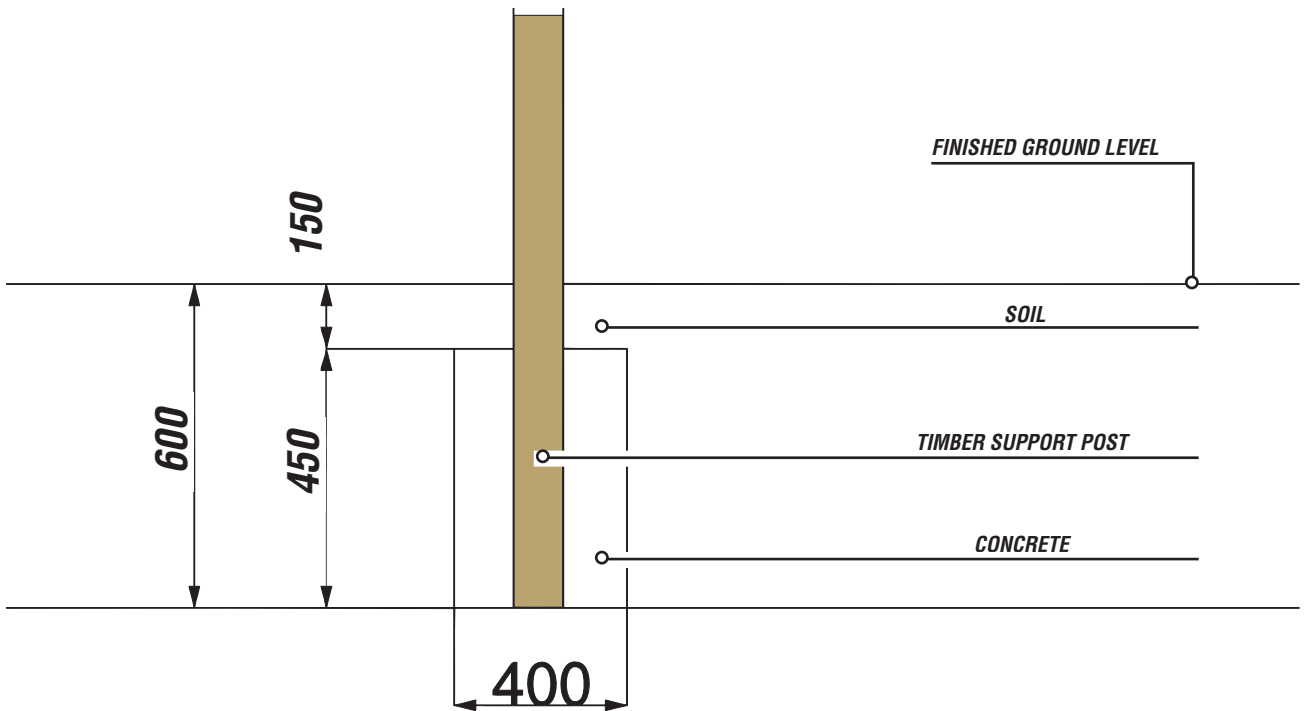
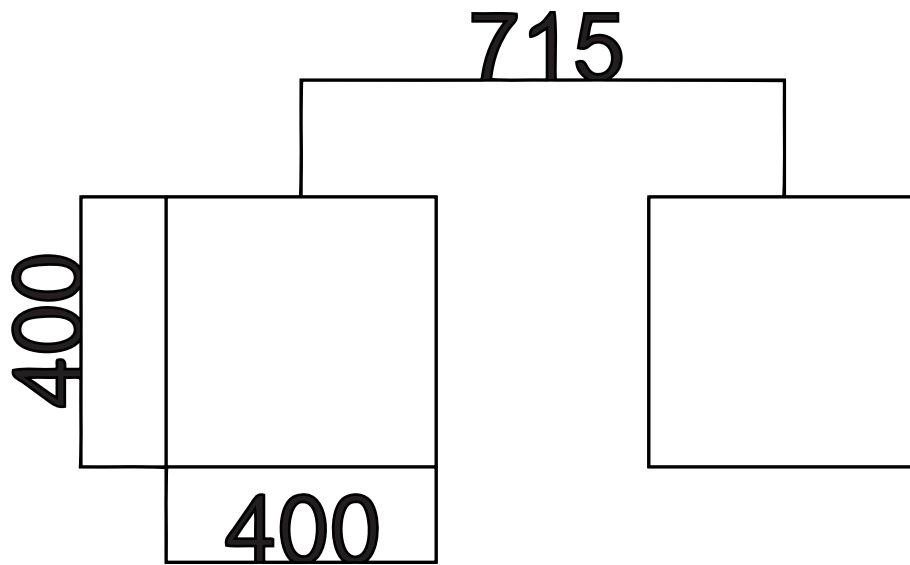

Installation Instructions

1

FIX BEATER TO LEFT TIMBER - BELOW MUSIC BOARD

USING 1 X FM80 BRASS WOOD SCREW

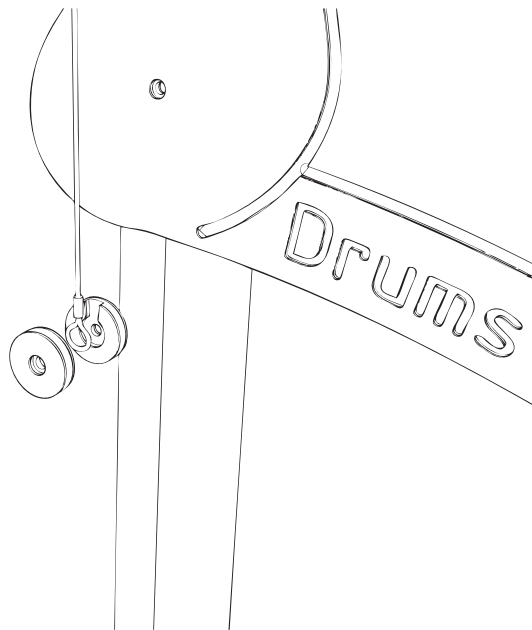

SANDWICH THE BEATER STEEL CORD LOOP BETWEEN THE PLAYTEC RING AND RECESSED PLAYTEC CIRCLE

FIX INTO PLACE USING 1 X FM80 BRASS WOOD SCREW

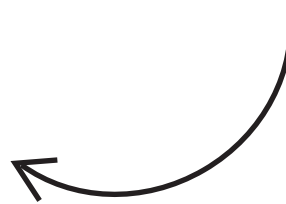

2

FIX BEATER HOLDER TO LEFT TIMBER - ABOVE MUSIC BOARD

USING 2 X FM80 BRASS WOOD SCREWS

PUSH PLAYTEC BLOCK THROUGH THE HOLDER AND MATCH UP THE TWO OBLONG PLAYTECS PIECES TO THE HOLES

FIX INTO TIMBER WITH 2 FM80 BRASS WOOD SCREWS.

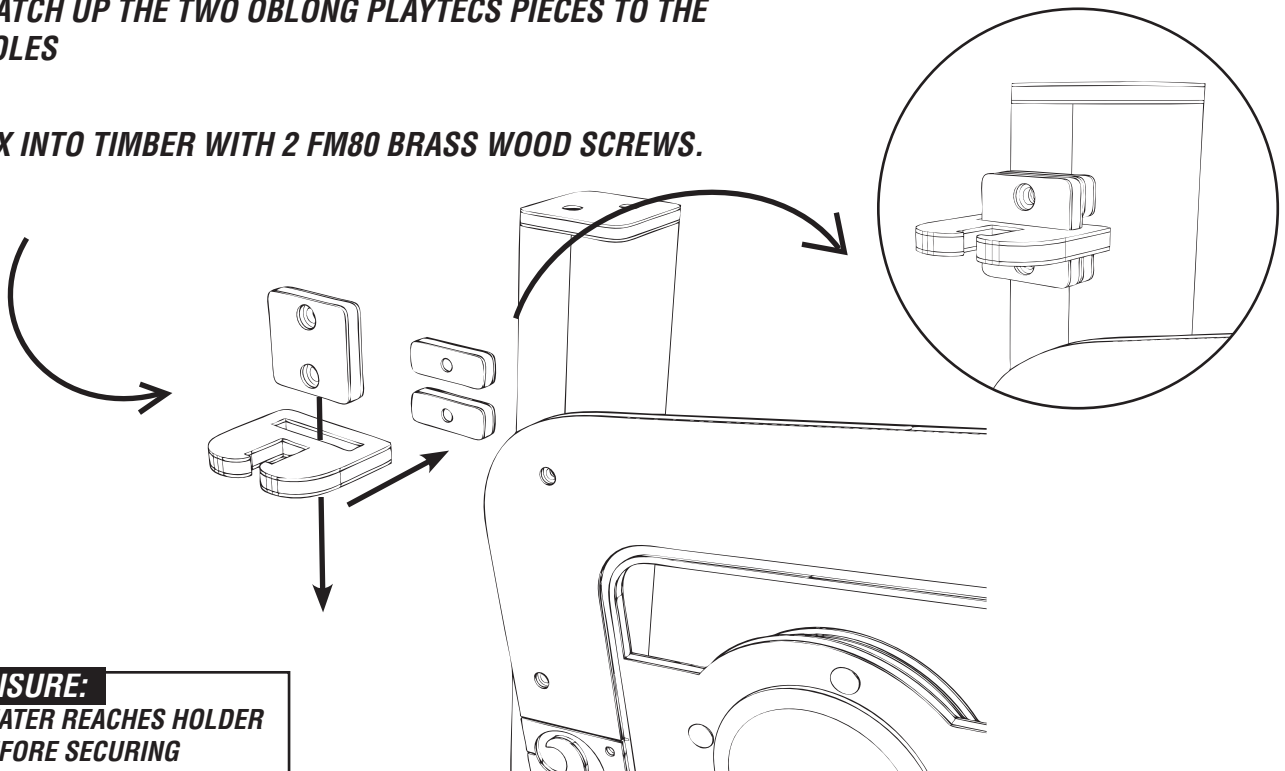

ENSURE:
BEATER REACHES HOLDER
BEFORE SECURING

Additional Dimensions

