

RAINWHEEL

Installation Instructions

**creative
play**

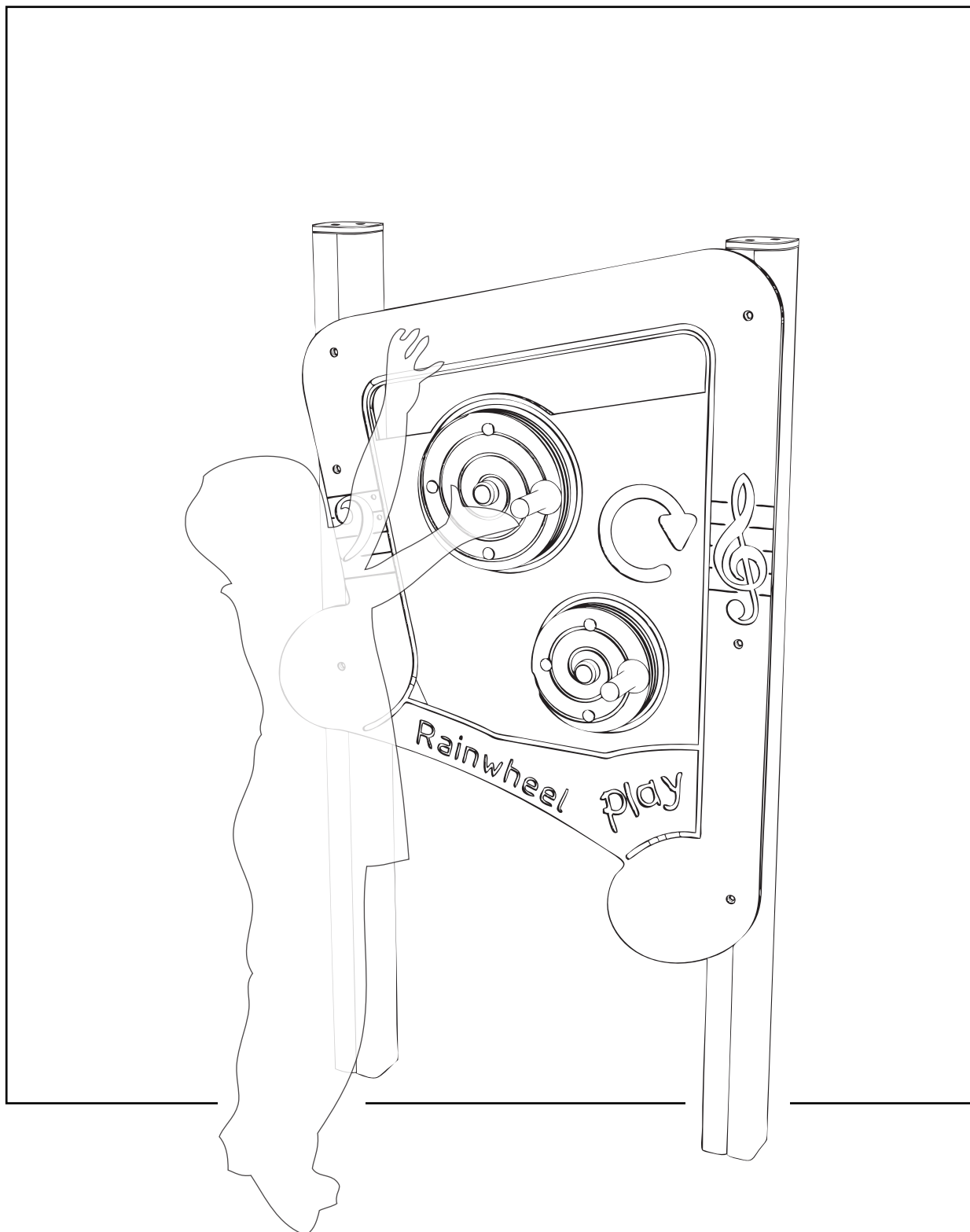

PARTS required

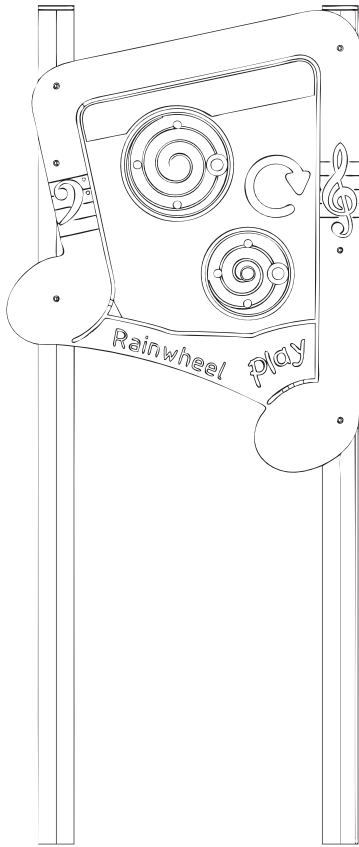

x1 PRE-ASSEMBLED MUSIC PLAY BOARD

TOOLS required

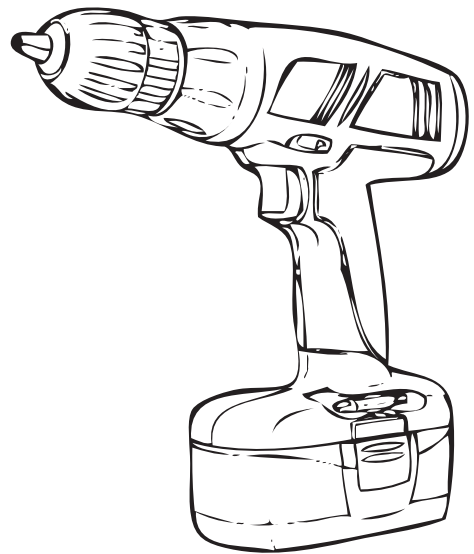
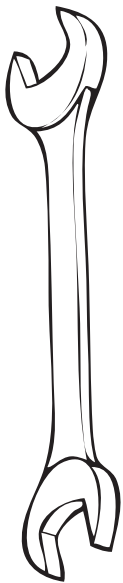

Foundation Details

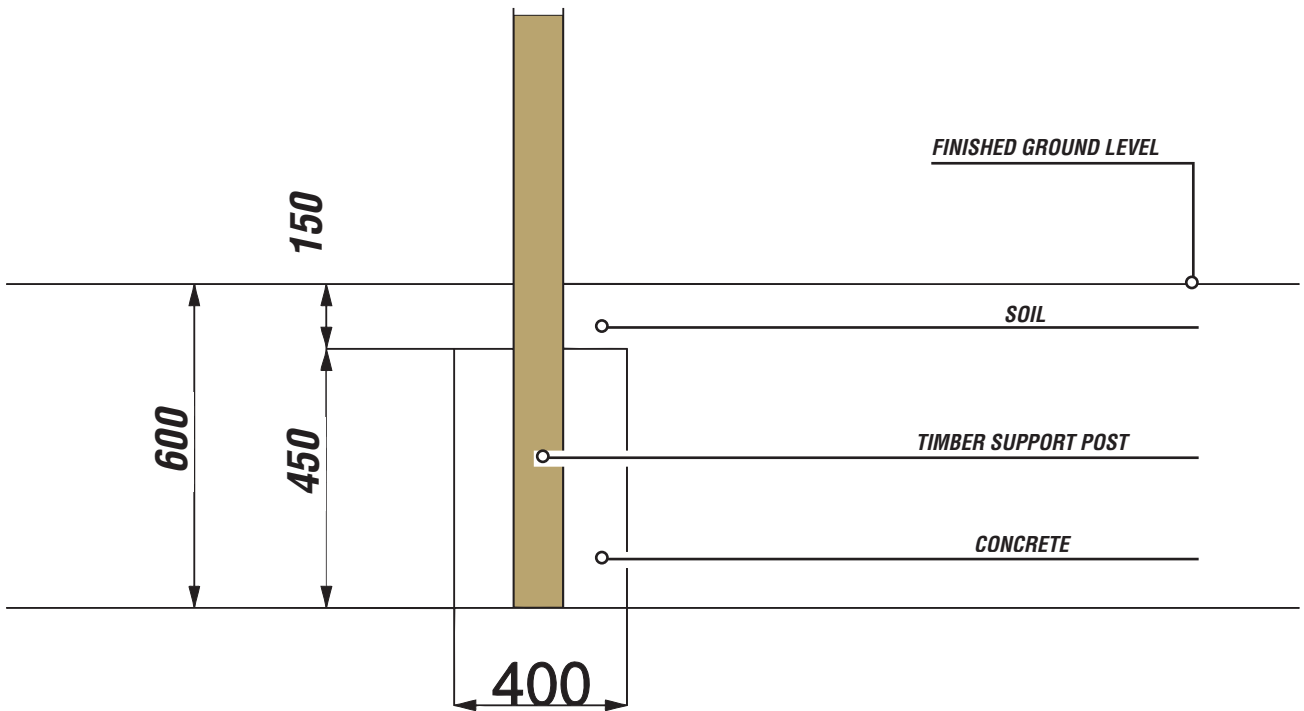
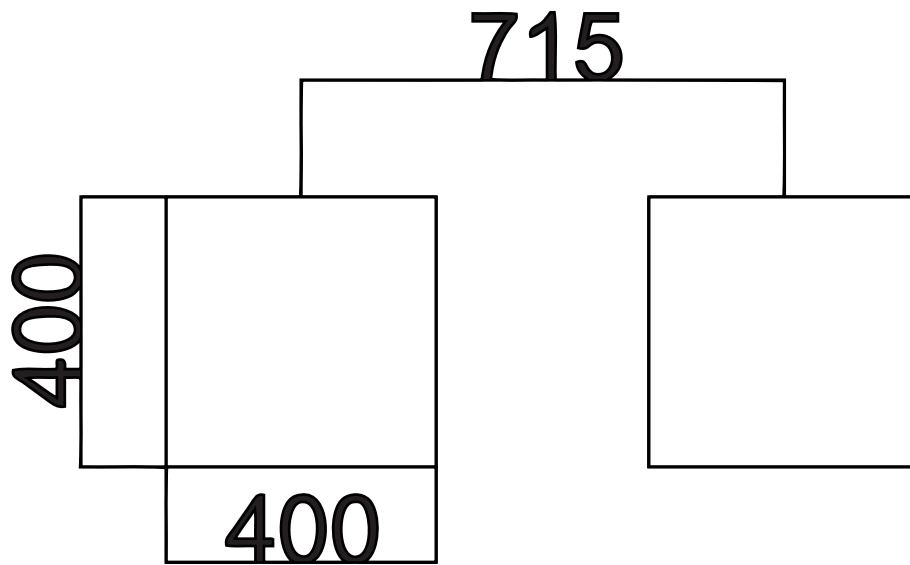

Installation Instructions

1

PUT PRE-ASSEMBLED MUSIC BOARD INTO FOUNDATIONS

AS DETAILED ON PAGE 3

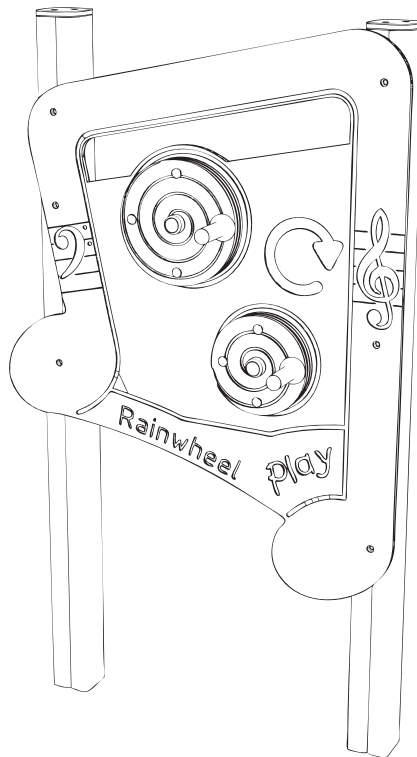

Additional Dimensions

