

# **GLOCKENSPIEL**

## ***Installation Instructions***

**creative  
play**

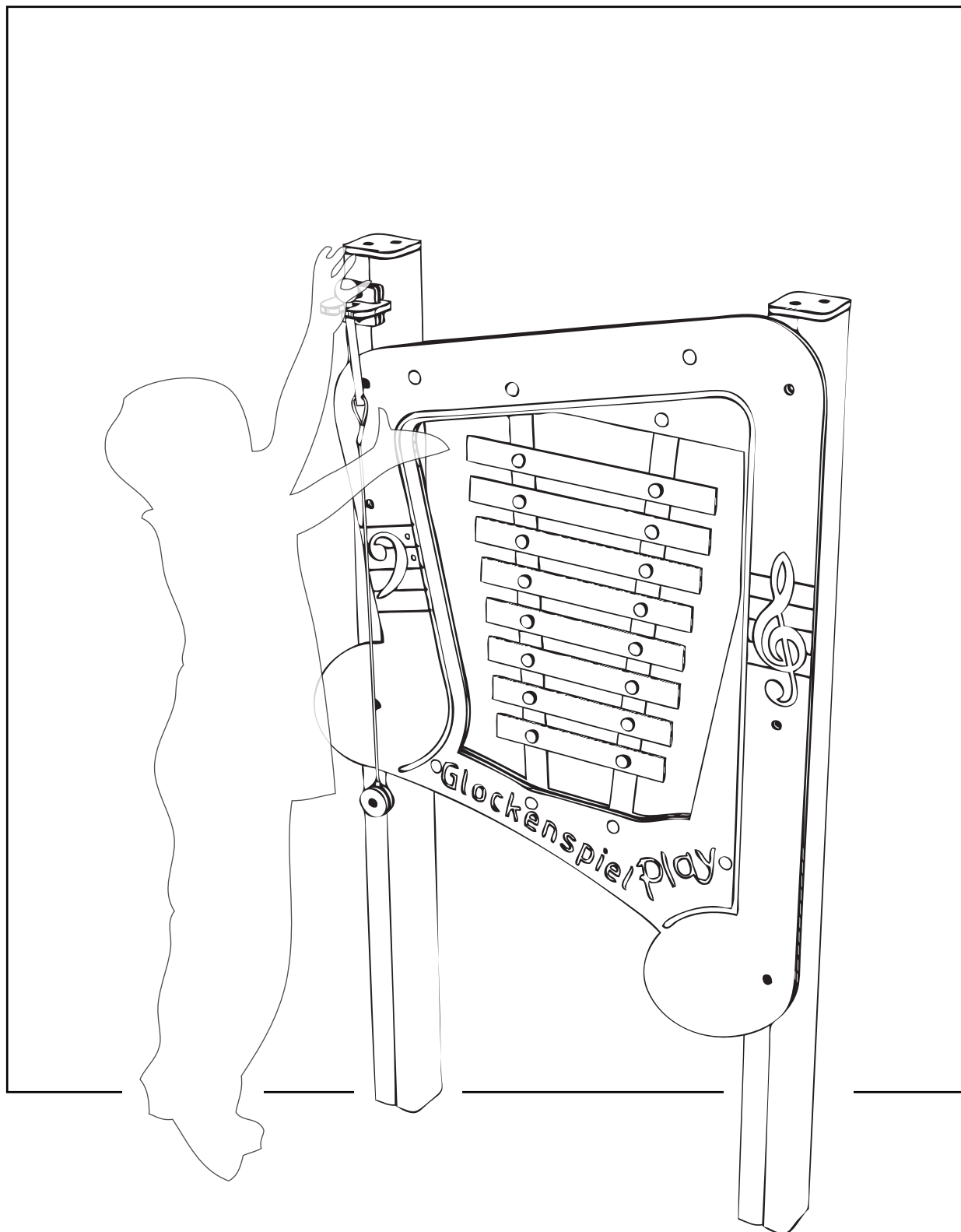

# PARTS required

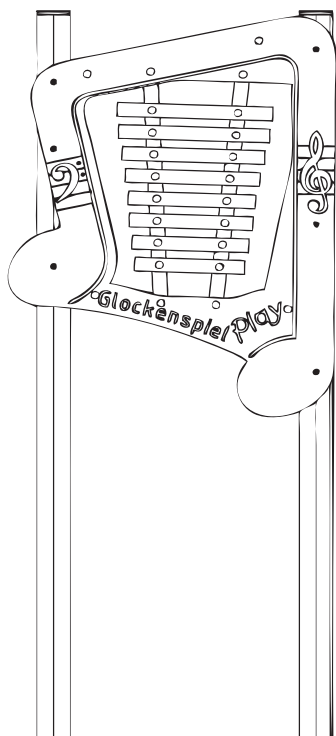

**x1** PRE-ASSEMBLED MUSIC PLAY BOARD



**x3** FM80 BRASS WOOD SCREWS

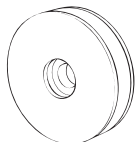

**x1** PLAYTEC RING



**x1** RECESSED PLAYTEC CIRCLE

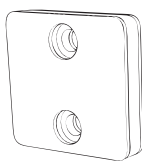

**x1** PLAYTEC BLOCK

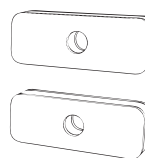

**x2** OBLONG PLAYTEC PIECES

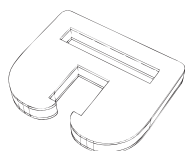

**x1** PLAYTEC BEATER HOLDER



**x1** BEATER WITH STEEL CORD

# TOOLS required



# Foundation Details

---

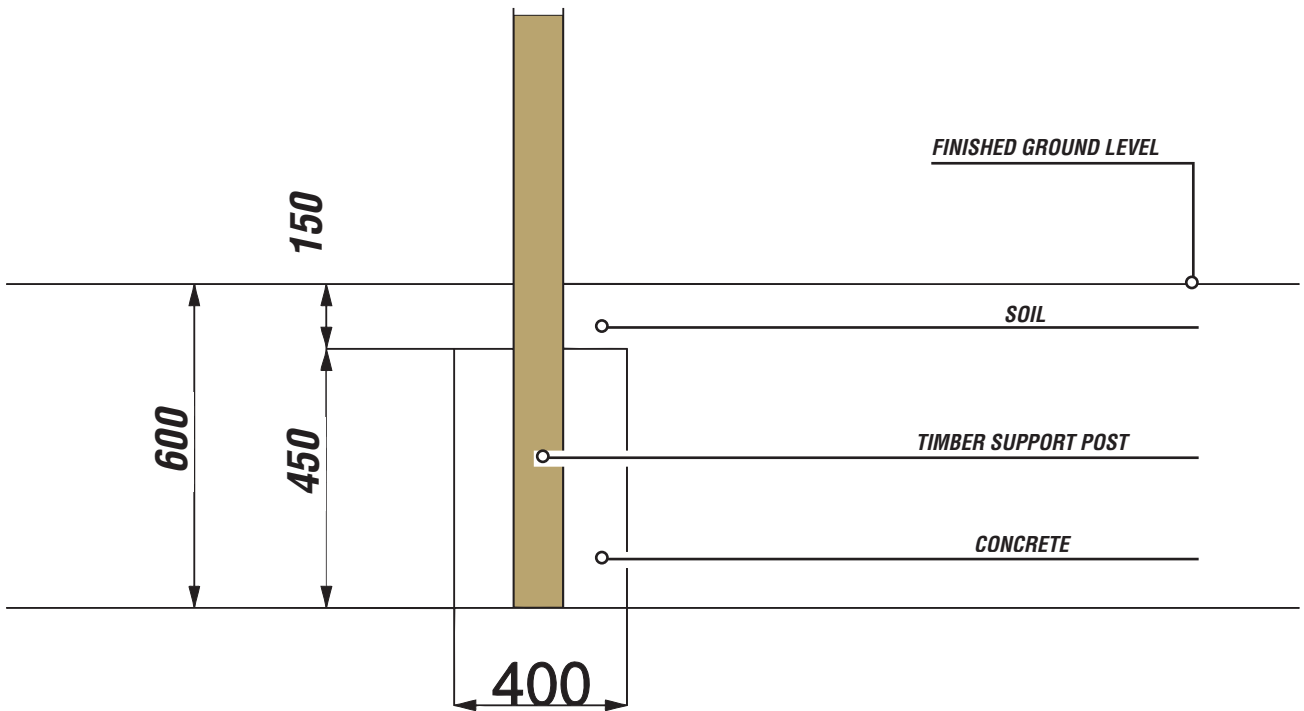
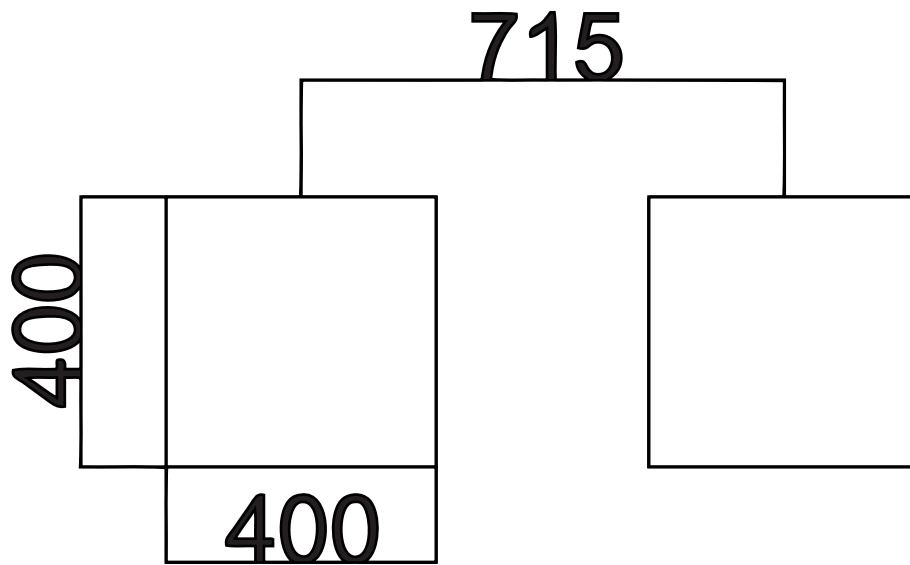

# Installation Instructions

**1**

## **FIX BEATER TO LEFT TIMBER - BELOW MUSIC BOARD**

USING 1 X FM80 BRASS WOOD SCREW

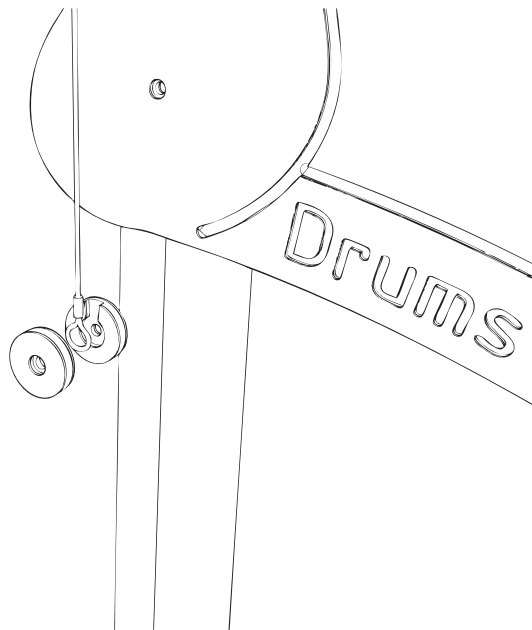

**SANDWICH THE BEATER STEEL CORD LOOP BETWEEN THE PLAYTEC RING AND RECESSED PLAYTEC CIRCLE**

**FIX INTO PLACE USING 1 X FM80 BRASS WOOD SCREW**

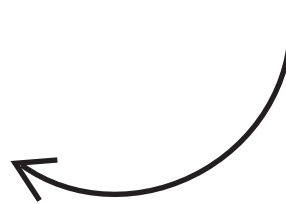

**2**

## **FIX BEATER HOLDER TO LEFT TIMBER - ABOVE MUSIC BOARD**

USING 2 X FM80 BRASS WOOD SCREWS

**PUSH PLAYTEC BLOCK THROUGH THE HOLDER AND MATCH UP THE TWO OBLONG PLAYTECS PIECES TO THE HOLES**

**FIX INTO TIMBER WITH 2 FM80 BRASS WOOD SCREWS.**

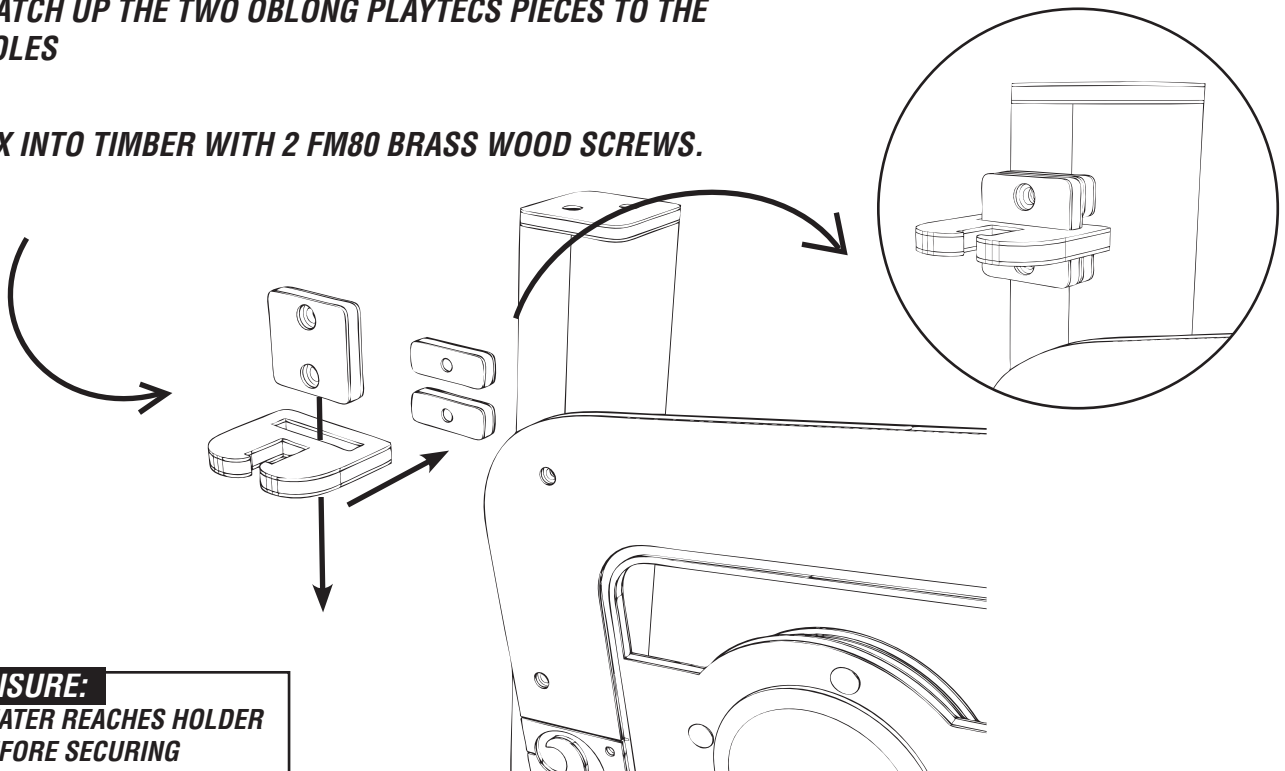

**ENSURE:**  
**BEATER REACHES HOLDER**  
**BEFORE SECURING**

# Additional Dimensions

---

