

TIMBER CLIMBING WALL

Installation Instructions

**creative
play**

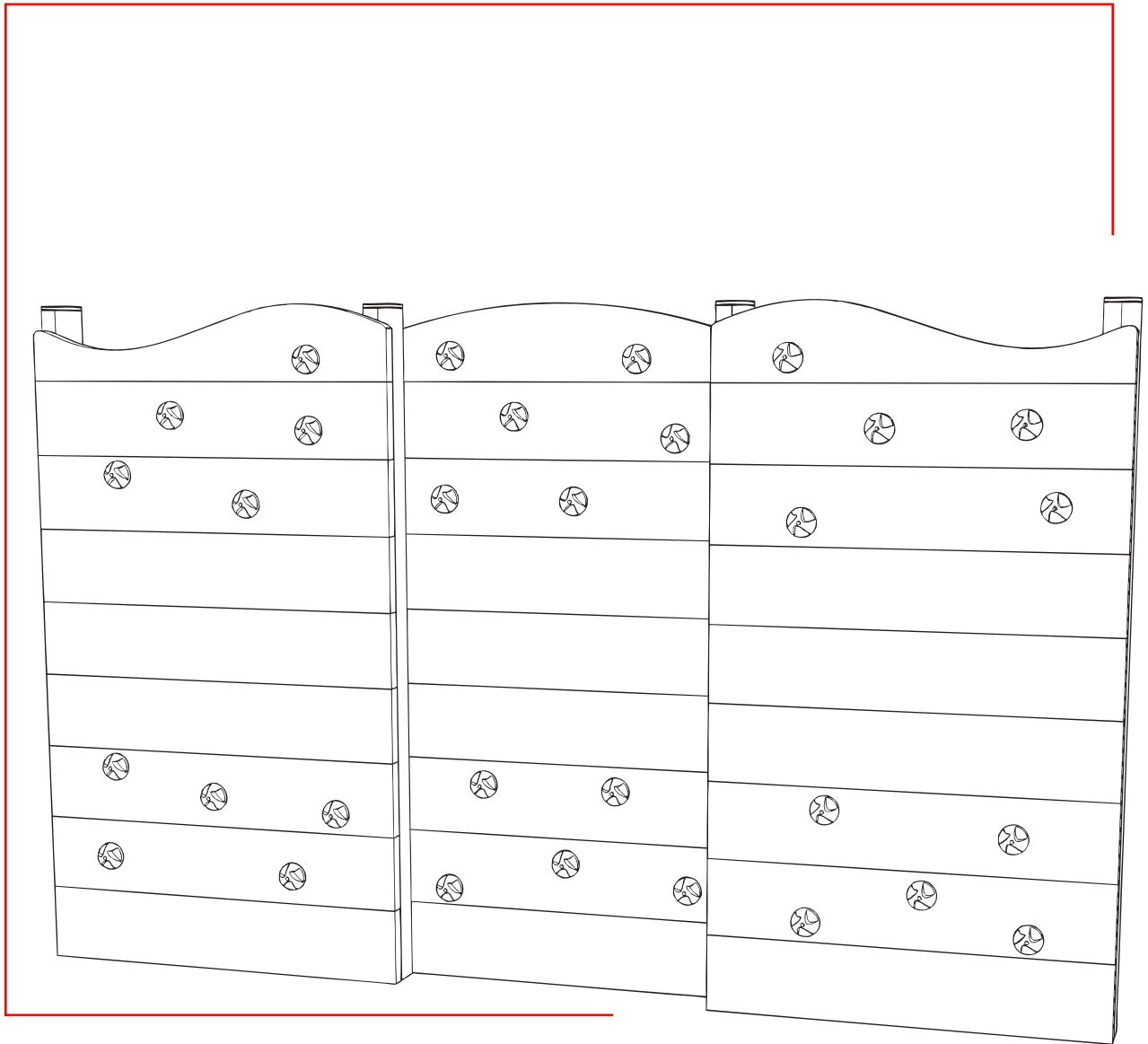

PARTS required

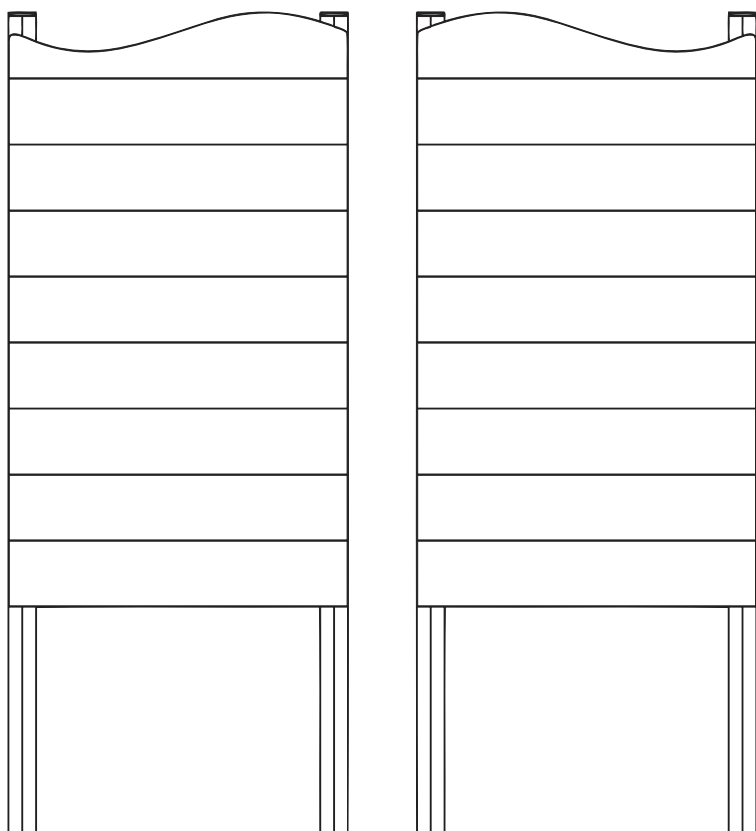

x1 (LEFT PANEL)

x1 (RIGHT PANEL)



RT4 x1



RT2 x8



x30 (CLIMBING BLOCKS)



x36 (FM80 'Brass screws')

TOOLS required

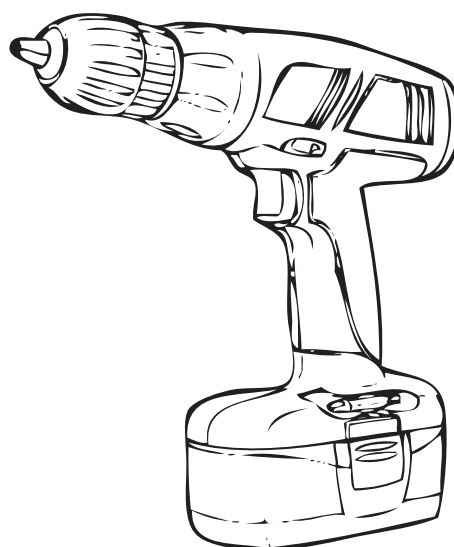

Foundation Details

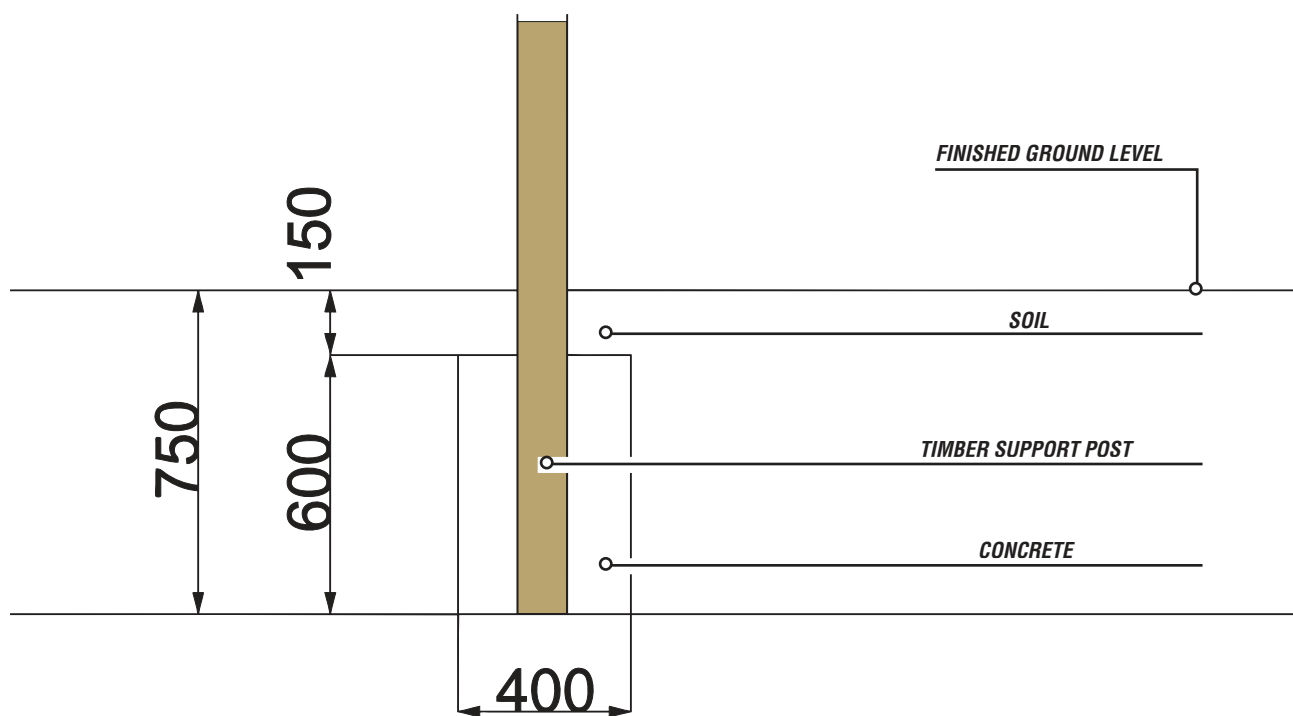
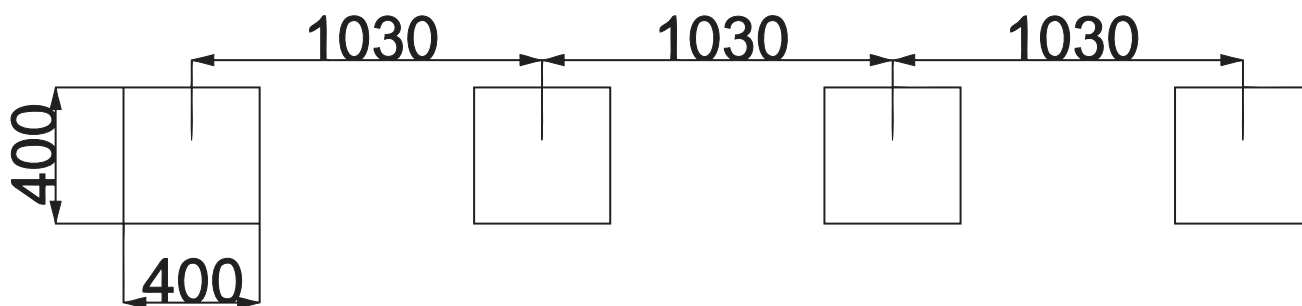

Surfacing Details

- - - - - = MINIMUM SPACE
- = SURFACE AREA

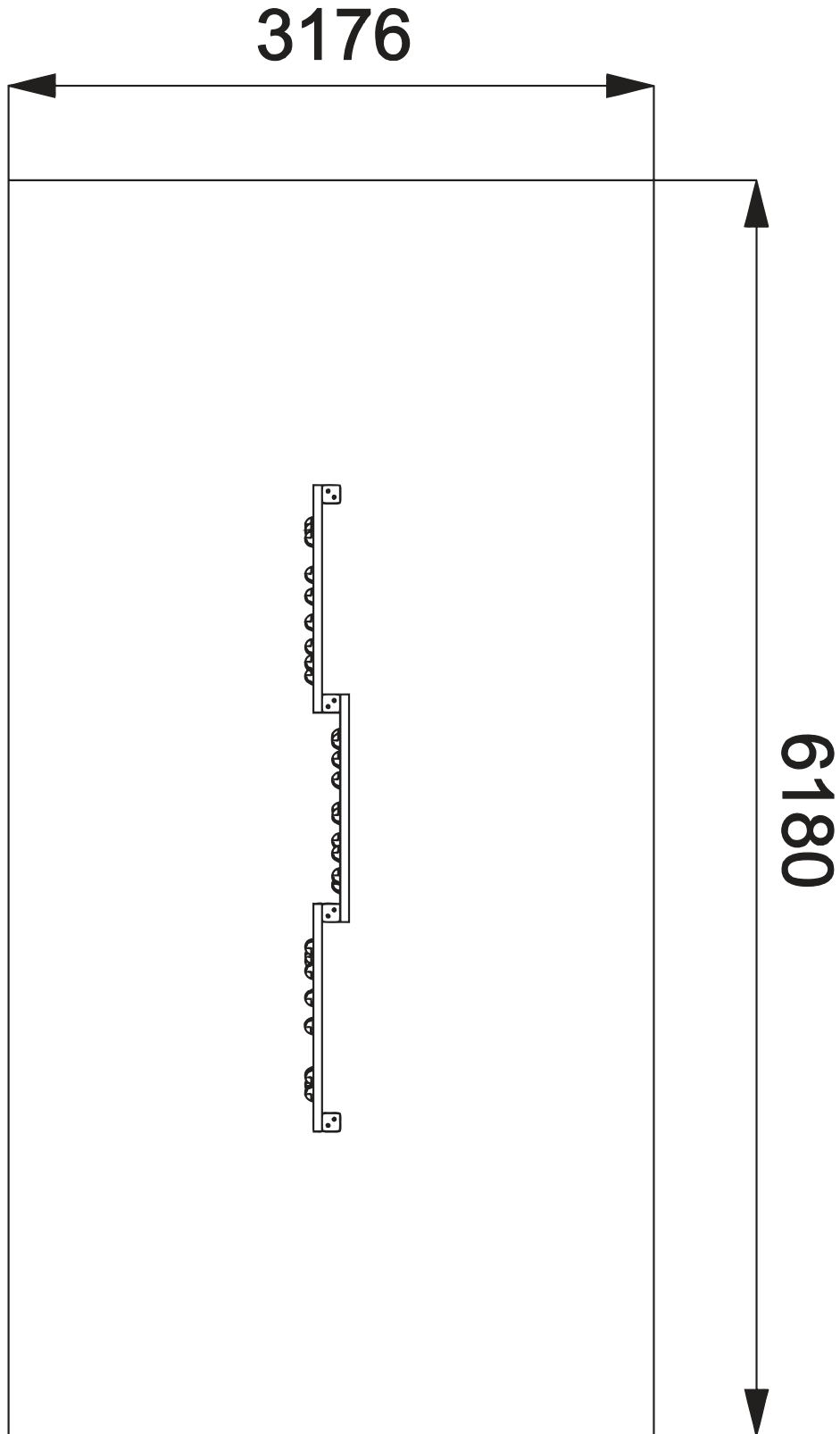

Installation Instructions

1

Install the LEFT and RIGHT PANELS

Follow foundation details

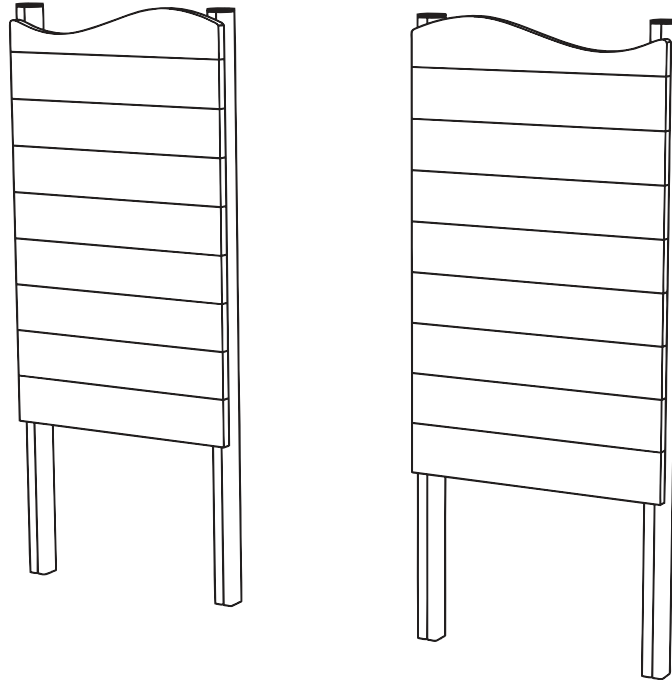

2

Attach TIMBERS RT2/4 to the TIMBERS RT1

Using 36x 'FM80 Brass Screws'

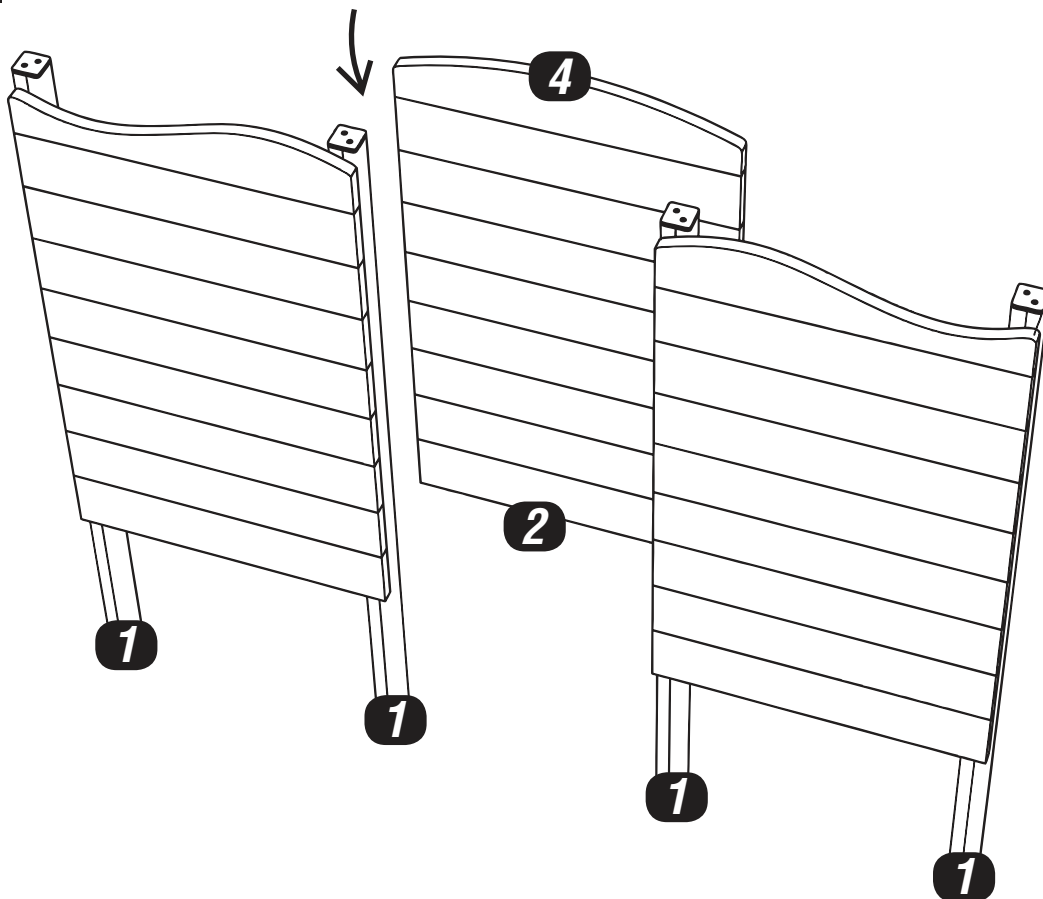

Installation Instructions

3

ATTACH CLIMBIN WALL BLOCKS to the PANELS

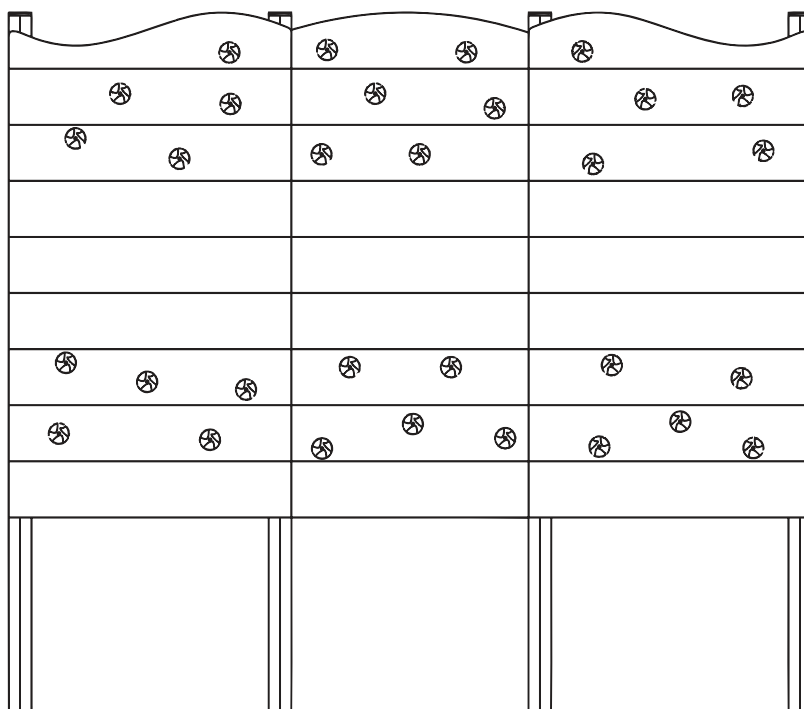
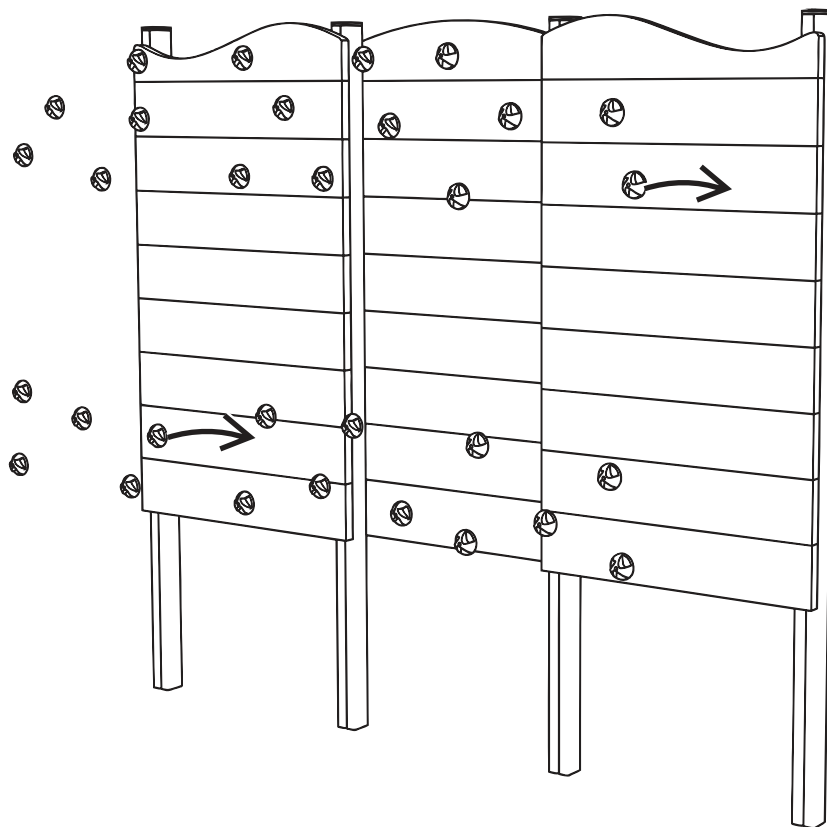

Additional Dimensions

3180

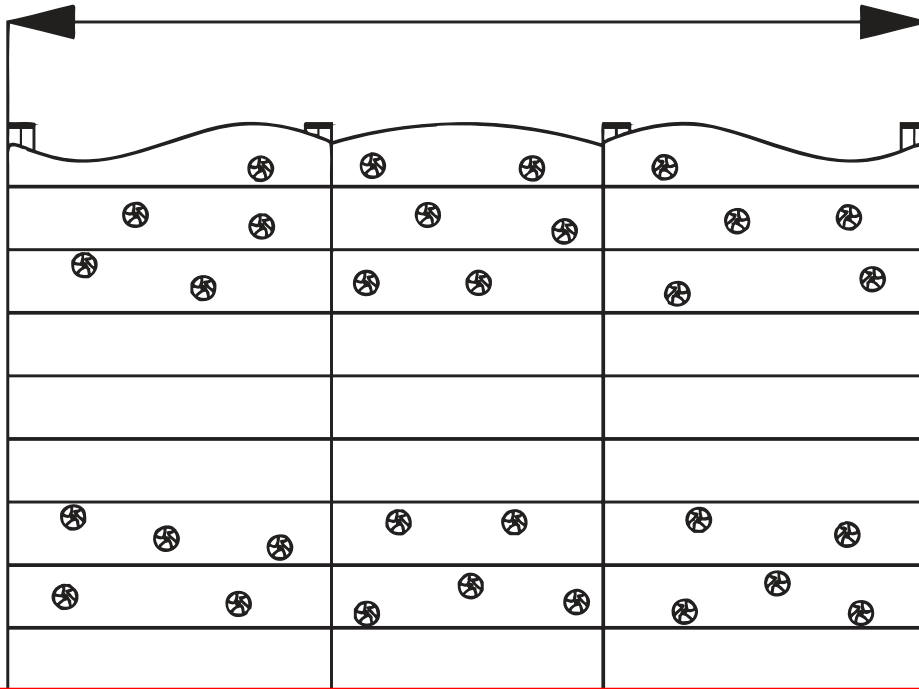

176

1962

