

GYM204 - PARALLEL BARS - JUNIOR

Installation Instructions

**creative
play**

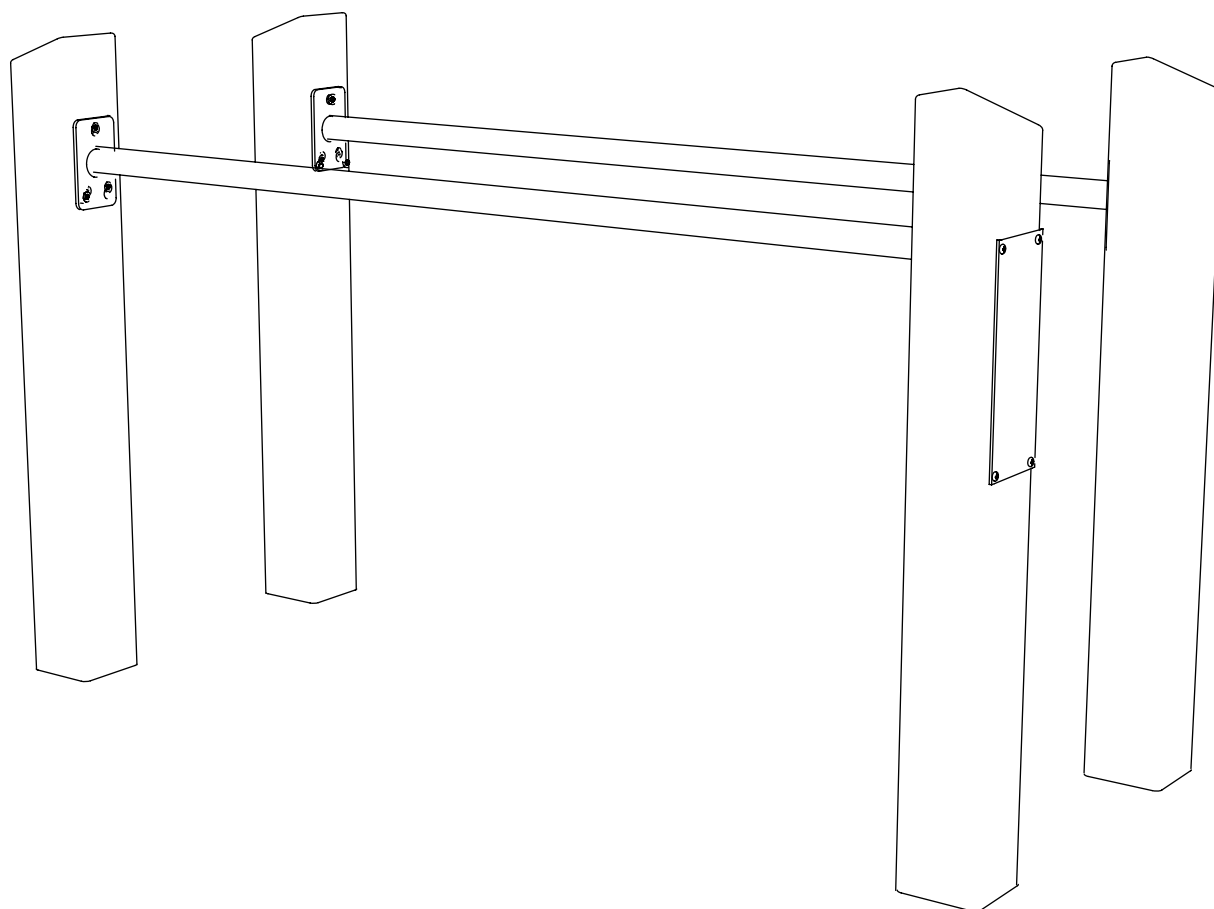

PARTS REQUIRED

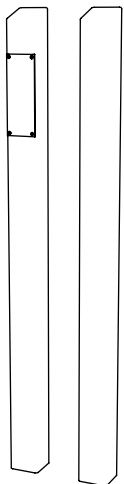

GM204-A [X3] & GM204-B [X1]

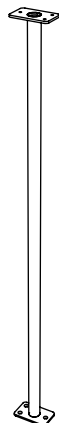

STANDARD BAR - 1480mm [X2]



M8 X 80 SCREWS [X6]

TOOLS REQUIRED

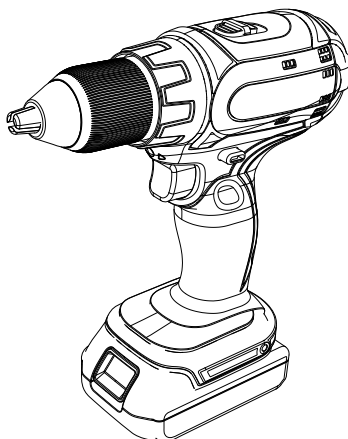
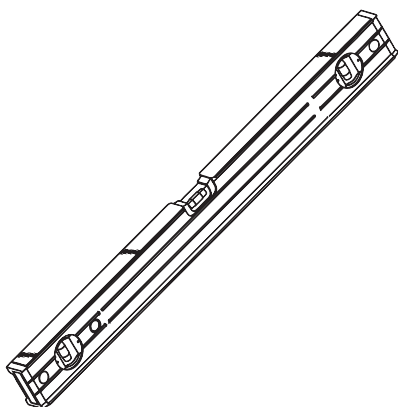

FOUNDATION DETAIL

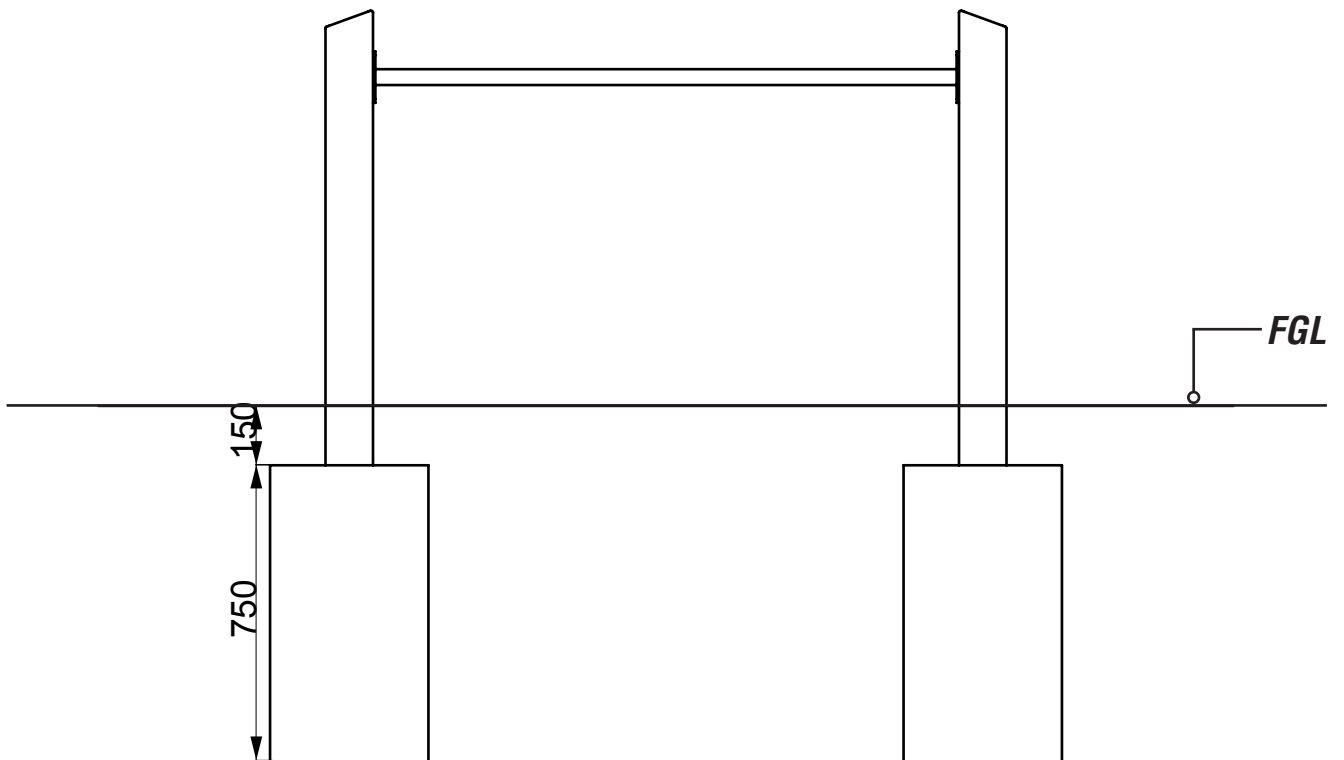
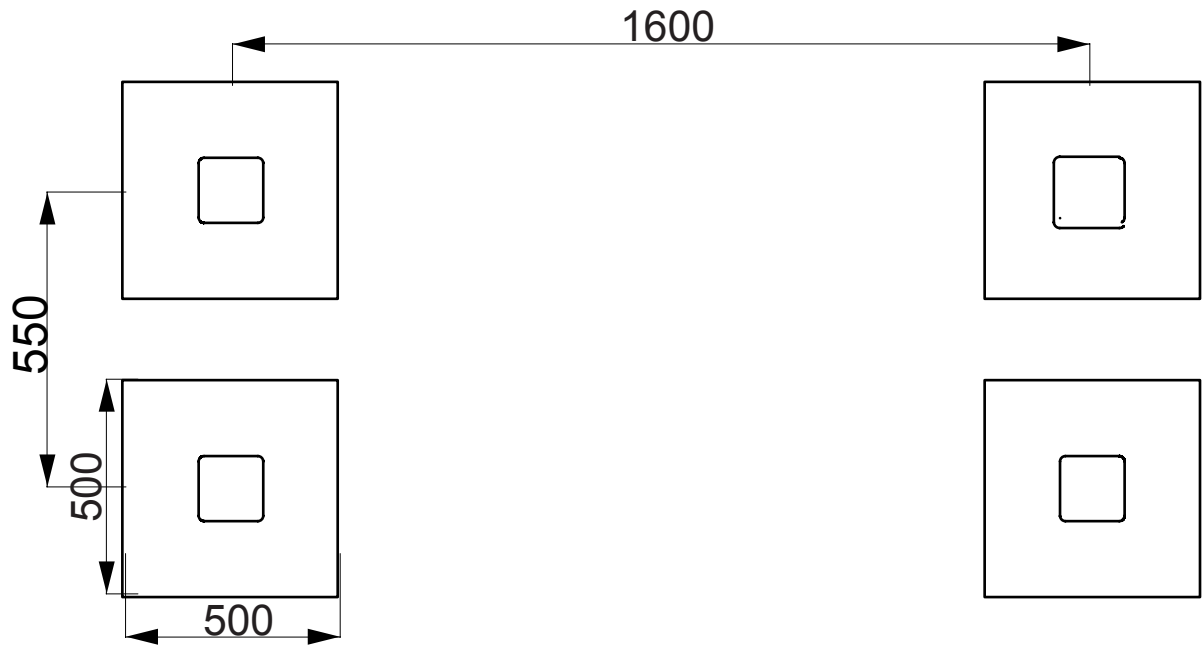

SURFACING - OVERALL AREA

— = EN16630 STANDARD

— = EN11-76/77 STANDARD

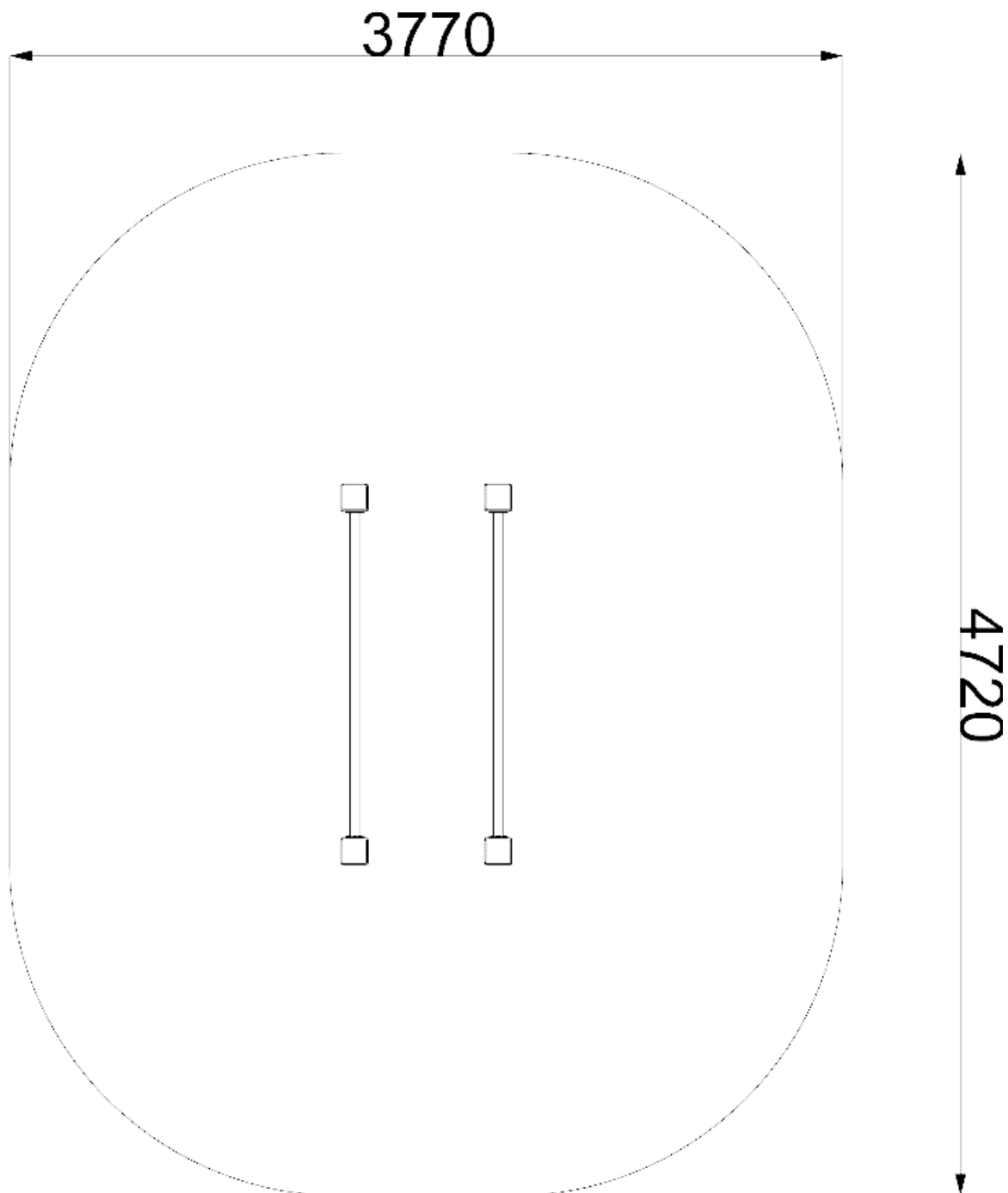

INSTALLATION INSTRUCTIONS

1

ATTACH STANDARD BAR TO GM204-A AND GM204-B TIMBERS
USING M8X80 SCREWS

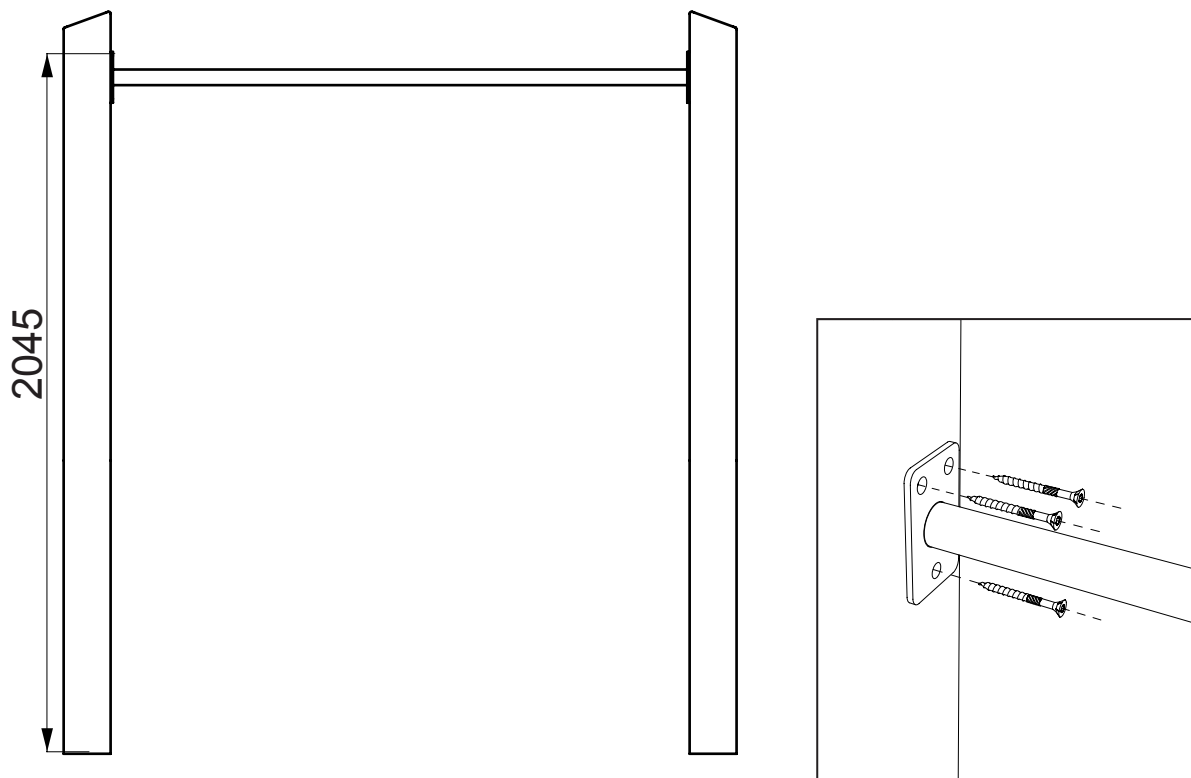

2

INSTALL GYM204 INTO THE GROUND

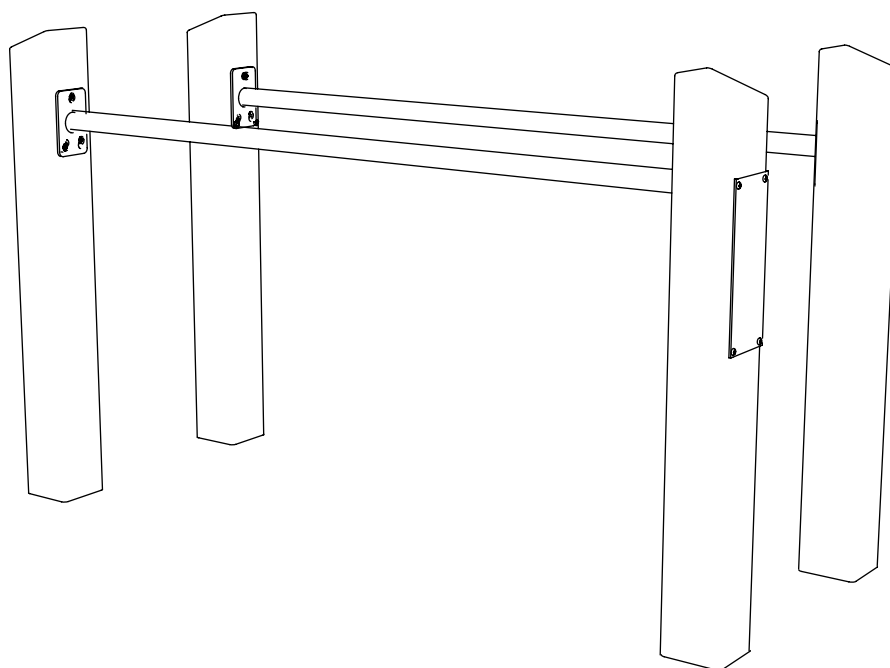

ADDITIONAL MEASUREMENTS

