

# **OS124 (4M) - WHITEBOARD**

## ***Installation Instructions***

**creative  
play**

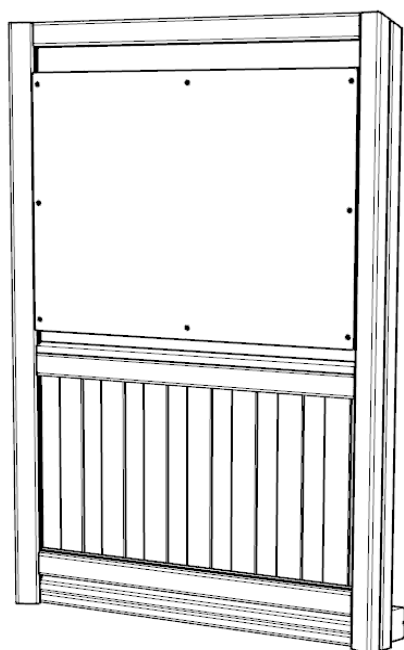
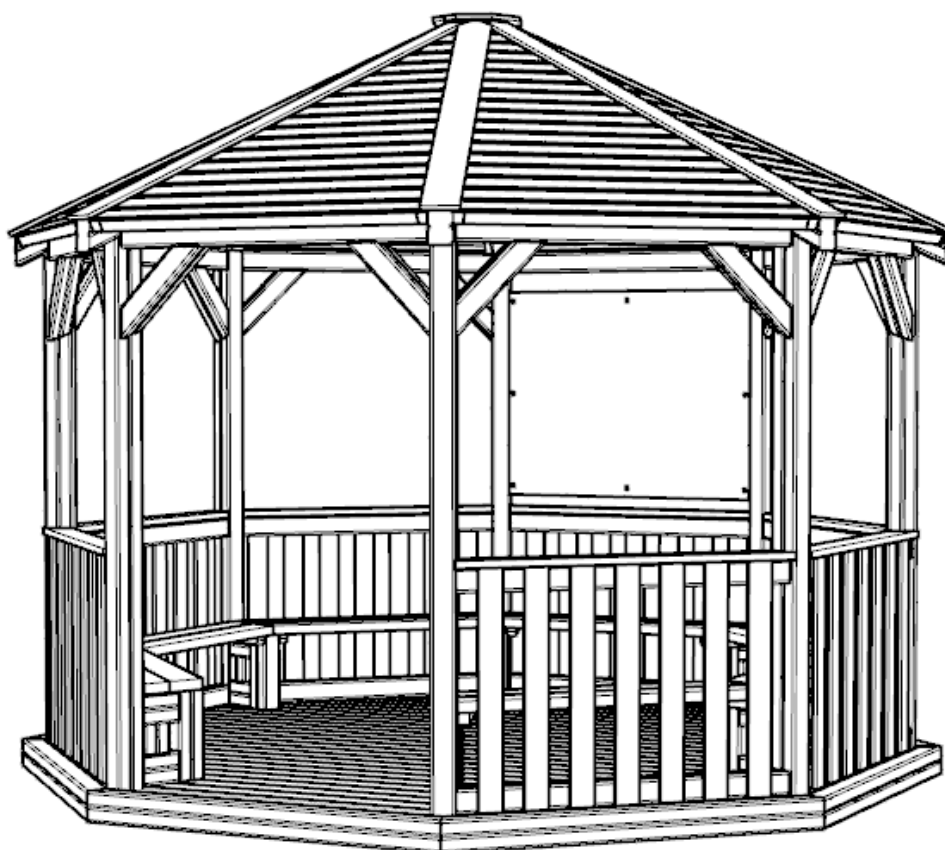

**INSIDE SHELTER VIEW**

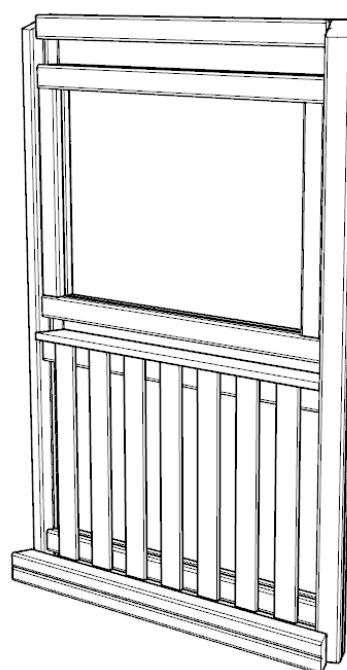

**OUTSIDE SHELTER VIEW**

# PARTS REQUIRED

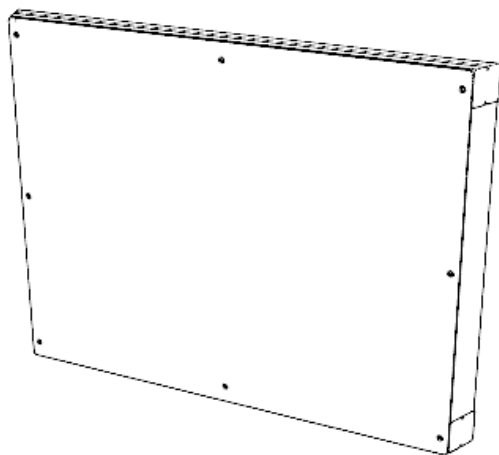

x1



x8

**PRE-ASSEMBLED WHITEBOARD PANEL**

**97.M8X120CSK**

**ENSURE ROOF BRACE TIMBERS (RB) ARE OMITTED DURING SHELTER INSTALL OR REMOVED PRIOR WHITEBOARD INSTALLATION - SEE BELOW**

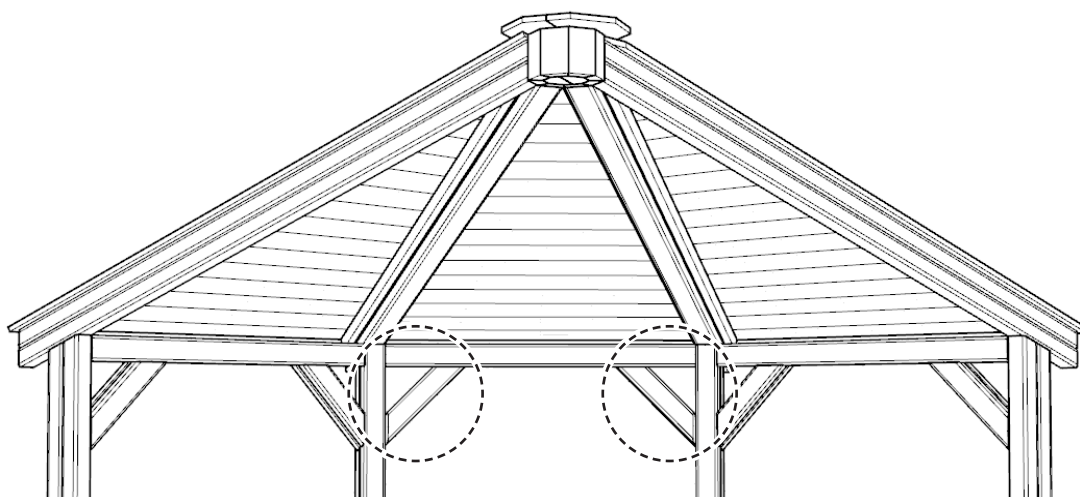

**BEFORE**

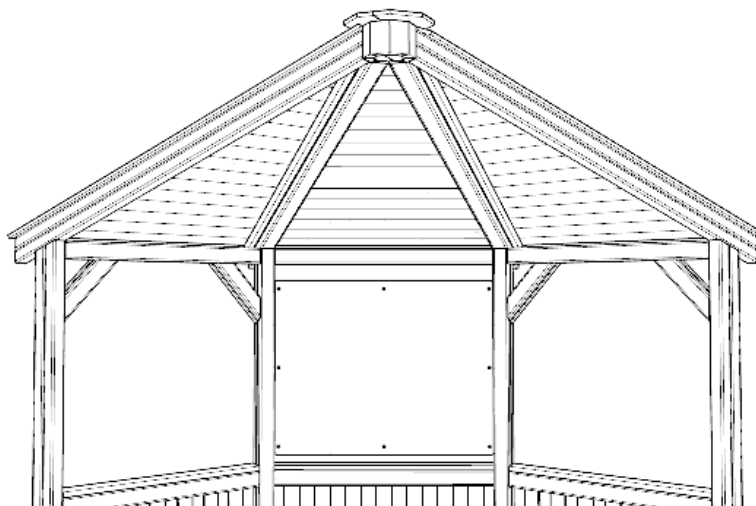

**AFTER**

# INSTALLATION INSTRUCTIONS

**1** SCREW WHITEBOARD PANEL TO SHELTER USING DIMENSIONS BELOW  
USING M8X120MM WOOD SCREWS, ENSURE IT IS POSITIONED ACCORDING TO DIAGRAMS SHOWN

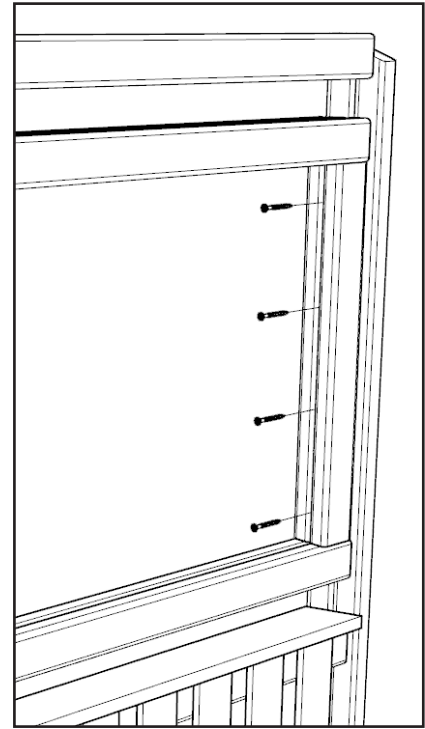
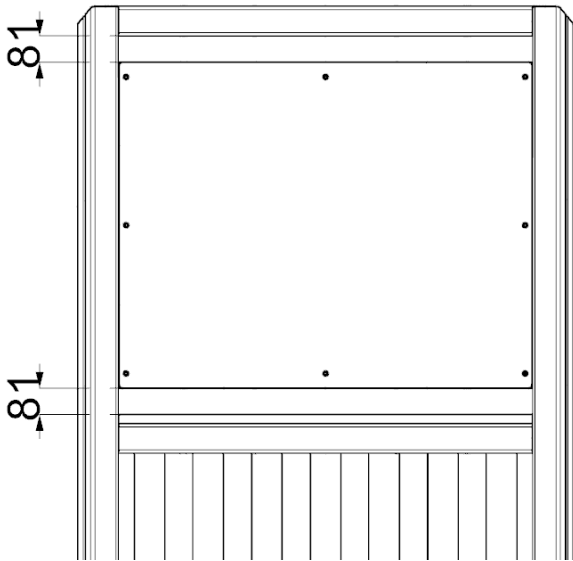

**NOTES:**  
ENSURE THERE IS AN 81MM GAP LEFT ABOVE AND BELOW  
WHITEBOARD  
4 SCREWS SHOULD BE INSTERTED EVENLY BOTH SIDES



**NOTES:**  
ENSURE WHITEBOARD TIMBER  
EDGE ON INSIDE OF SHELTER IS  
FLUSH WITH UPRIGHTS AS SHOWN

WHITEBOARD TIMBER  
WHITEBOARD ACRYLIC

