

OS122(5) - WINDOW SIDES

Installation Instructions

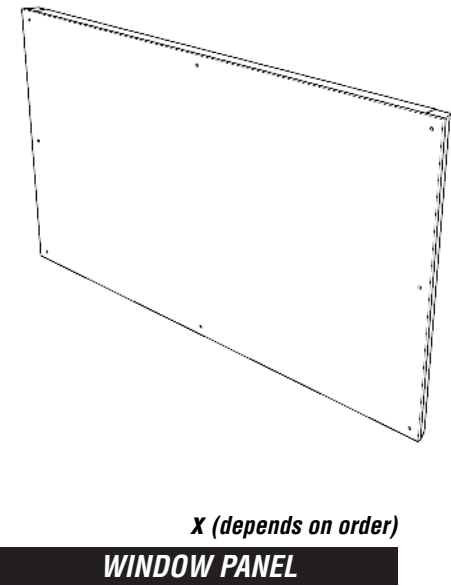
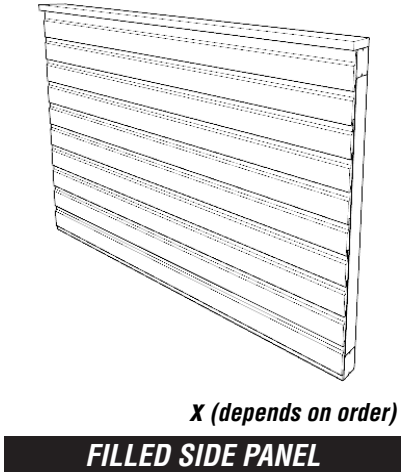
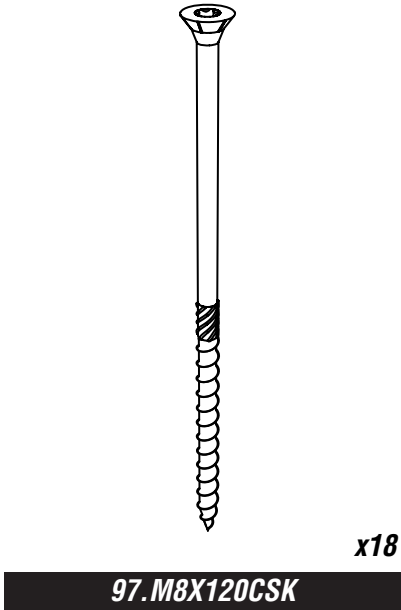
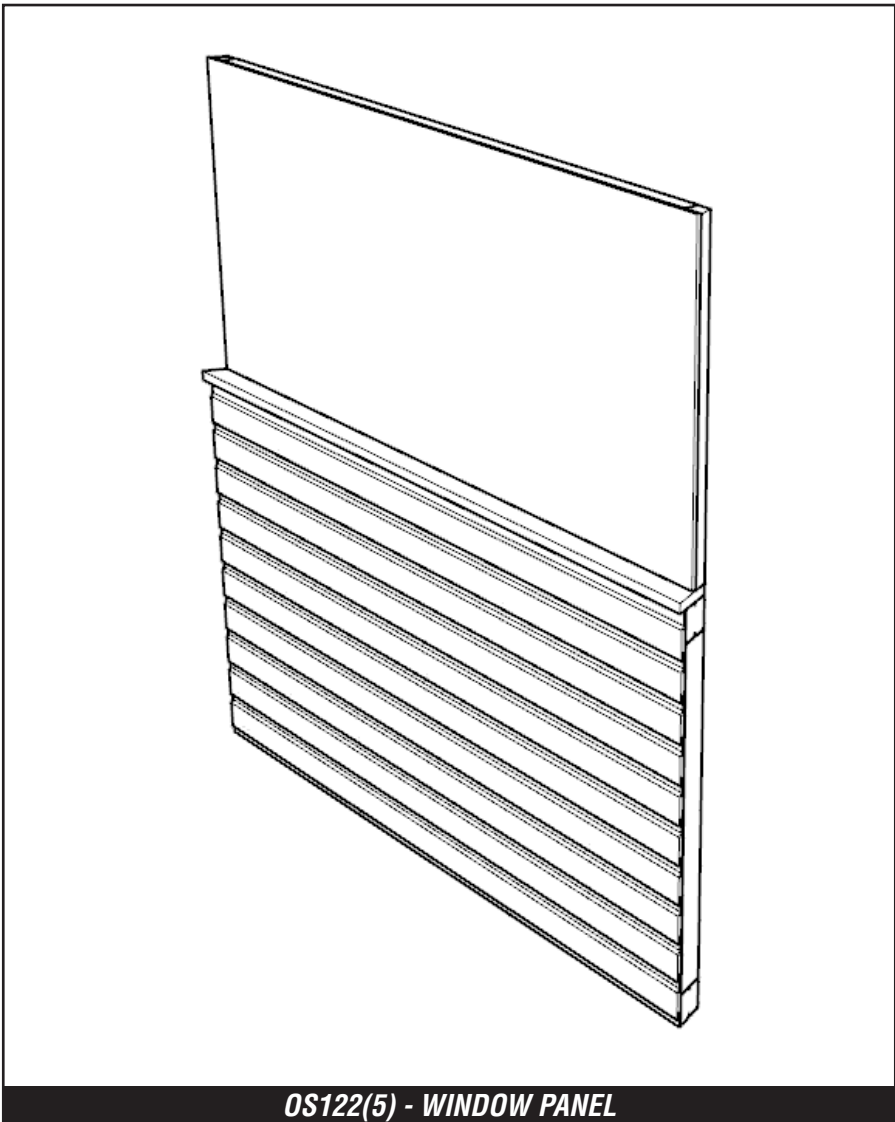

INSTALLATION INSTRUCTIONS

1

**INSTALL OR REPLACE EXISTING OCTAVIA WALL WITH FILLED SIDE PANELS
USING M8X120MM WOOD SCREWS**

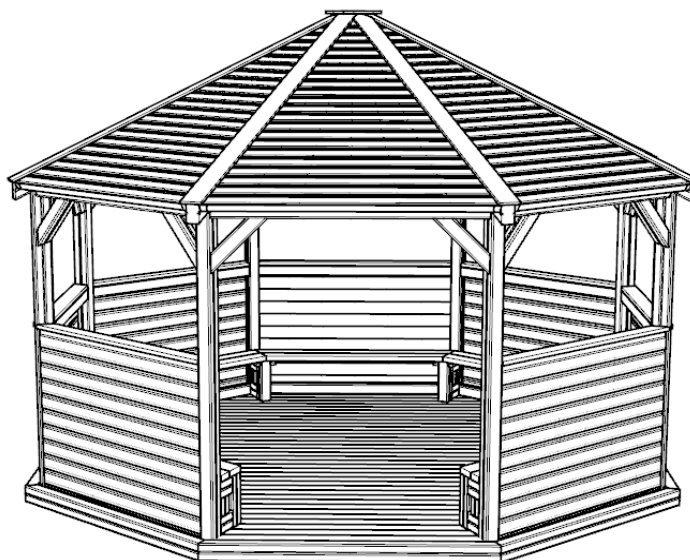

2

**ENSURE TIMBERS ARE PRE-DRILLED AND COUNTERSUNK
3X SCREWS PER SIDE**

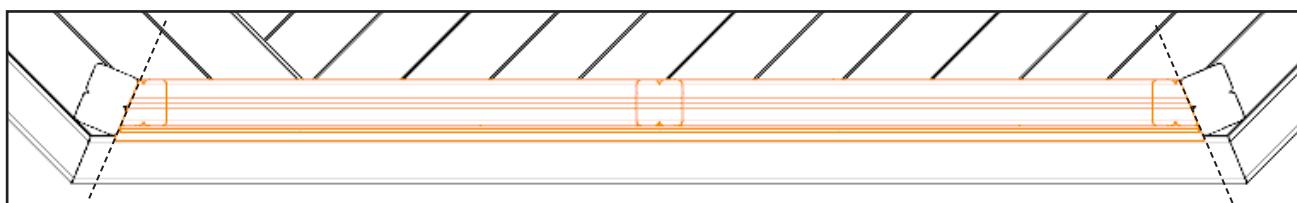
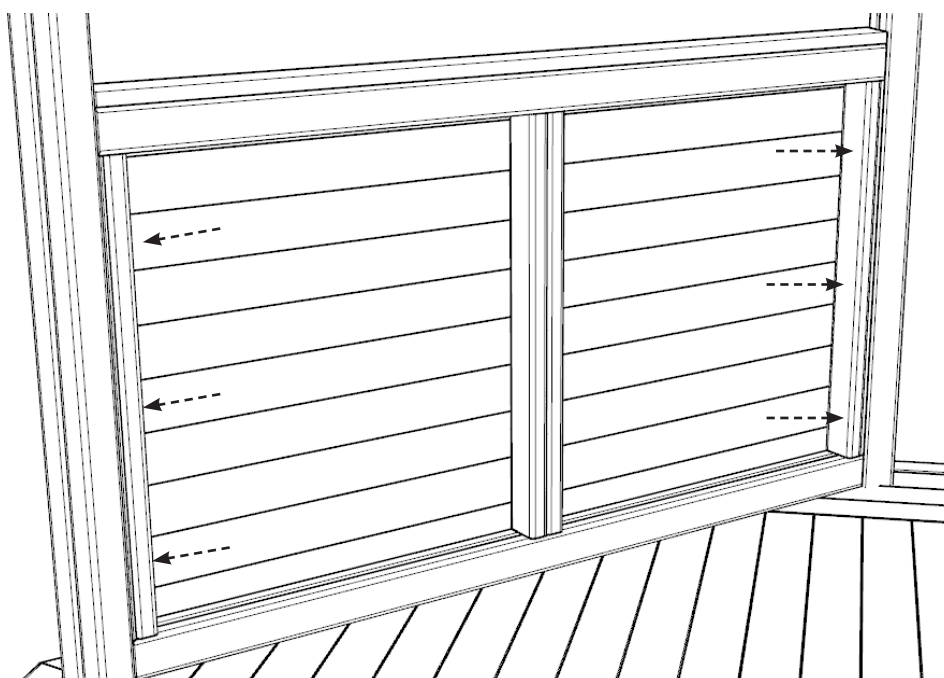

3

REMOVE ALL BRACE TIMBERS FROM OCTAVIA SIDES RECIEVING NEW WINDOW PANELS

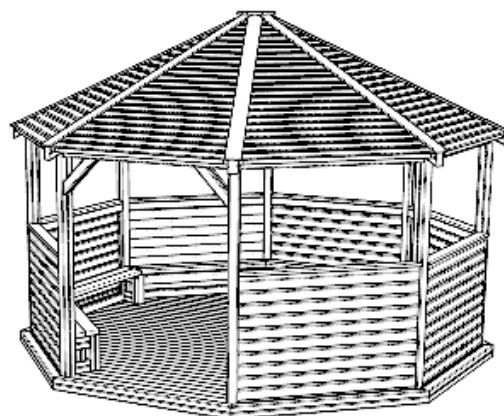
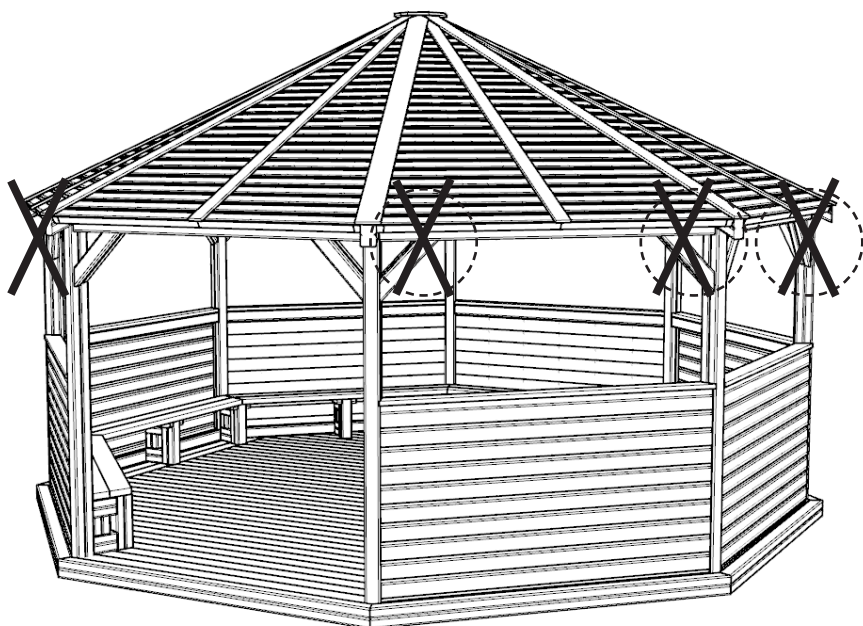
**4**

ATTACH WINDOW PANELS ON TOP OF FILLED SIDES AS SHOWN

USING X12 M8X120MM WOOD SCREWS, POSITION AS SHOWN (GREY SHADING = WINDOW TIMBER) ...

