

**WO109 - EPPING**  
***Installation Instructions***

**creative  
play**

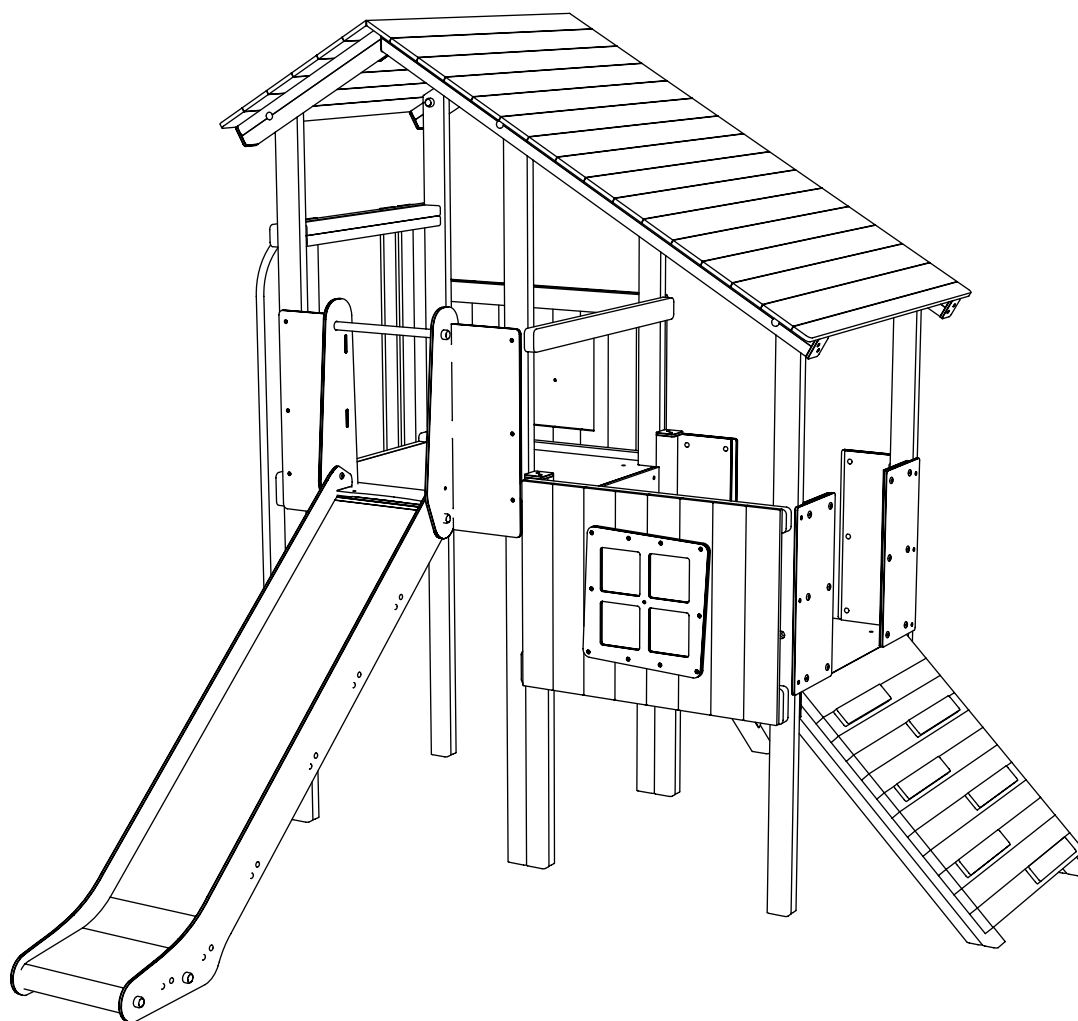

# PARTS REQUIRED

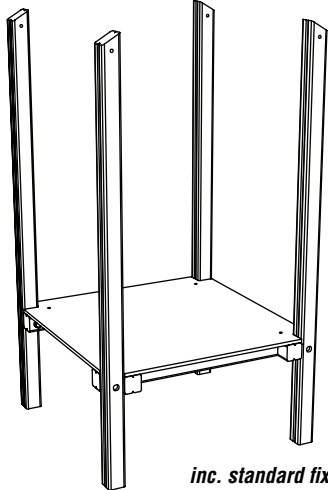

*inc. standard fixings*

**STANDARD JIGSAW PART**  
**JIG1502 - ROOF PLATFORM - 1.5M**

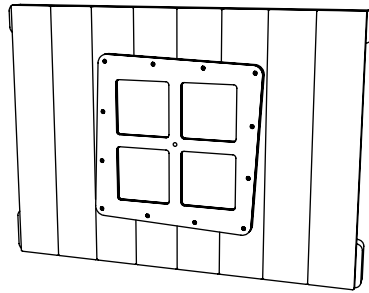

*inc. standard fixings*

**STANDARD JIGSAW PART**  
**JIG111 - GUARD RAIL - WINDOW [X2]**

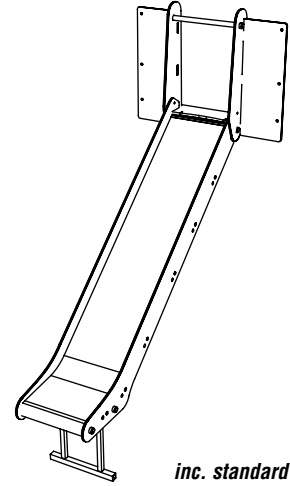

*inc. standard fixings*

**STANDARD JIGSAW PART**  
**JIG1511 - SLIDE - 1.5M**

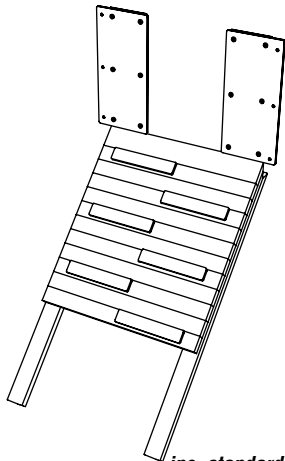

*inc. standard fixings*

**STANDARD JIGSAW PART**  
**JIG913 - RAMP - 0.9M**

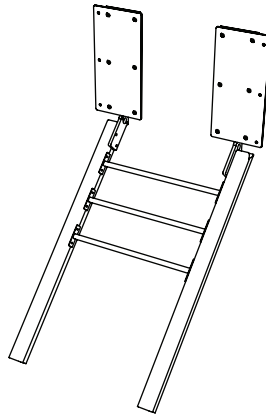

*inc. standard fixings*

**STANDARD JIGSAW PART**  
**JIG917 - INCLINED RUNG LADDER - 0.9M**

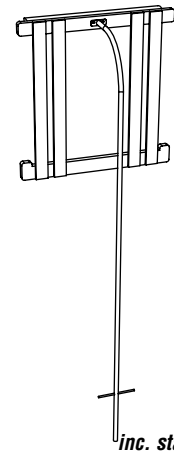

*inc. standard fixings*

**STANDARD JIGSAW PART**  
**JIG1517 - FIREFIGHTERS POLE - 1.5M**

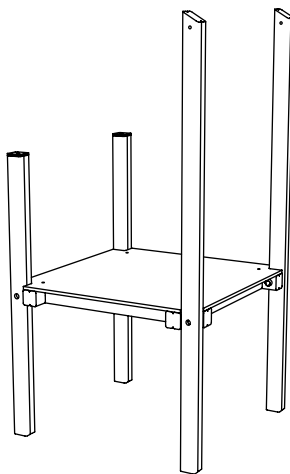

**WO109 SPECIFIC PART**  
**0.9M PLATFORM**

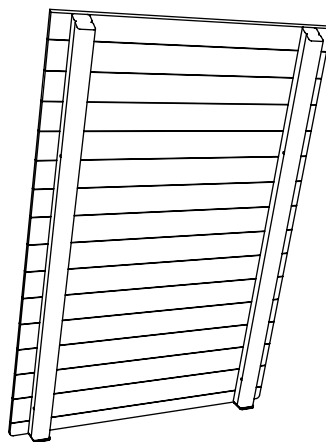

**WO109 SPECIFIC PART**  
**LARGE ROOF ASSEMBLY**

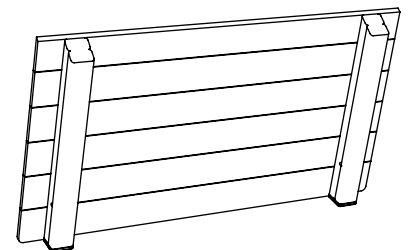

**WO103 SPECIFIC PART**  
**SMALL ROOF ASSEMBLY INC BRACKETS**

# PARTS REQUIRED

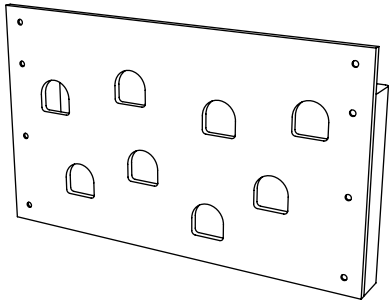

**W0109 SPECIFIC PART**

**SPLIT LEVEL CLIMBER**

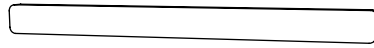

**W0109 SPECIFIC PART**

**W0190-G TIMBER**

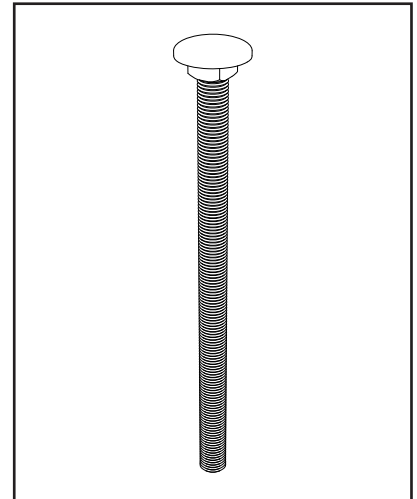

**W0103 - EXTRA FIXINGS**

**M12X200 BOLT [X6]**

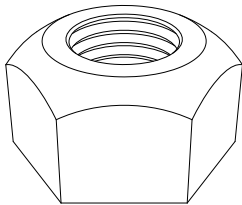

**W0103 - EXTRA FIXINGS**

**M12 NYLOCS [X6]**

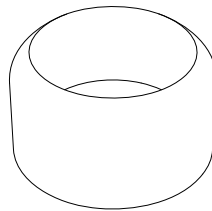
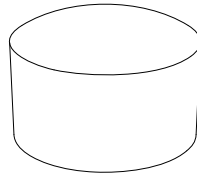

**W0103 - EXTRA FIXINGS**

**COVERED ENDS [X6]**

**FOR ANY STANDARD JIGSAW  
PART USE THE STANDARD  
JIGSAW INSTALLATION  
INSTRUCTIONS**

**STANDARD JIGSAW PART**

# TOOLS REQUIRED

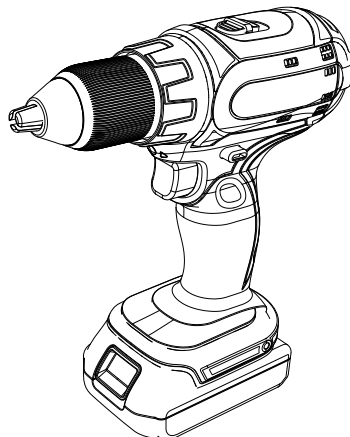
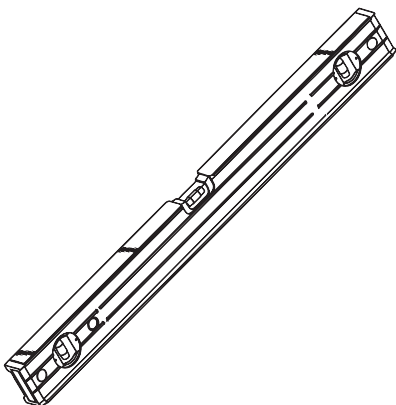

# FOUNDATION DETAIL

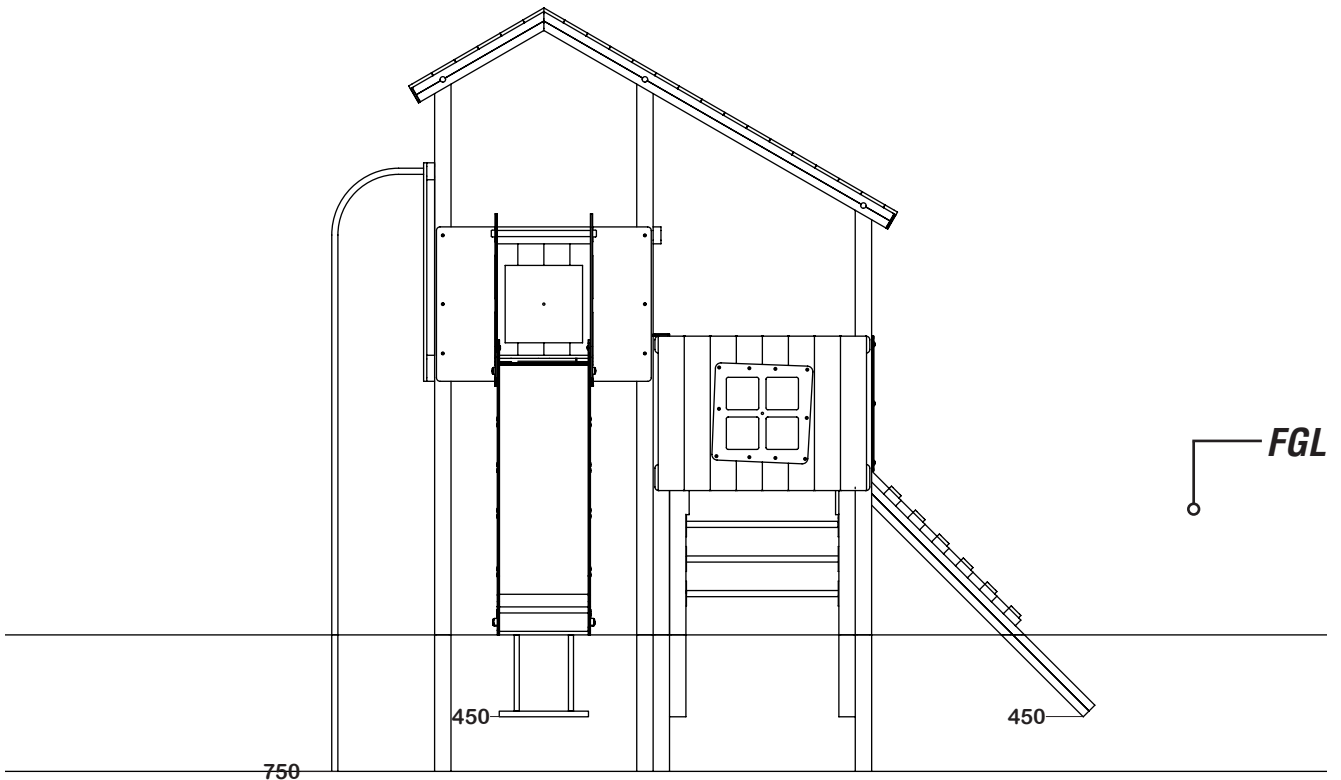
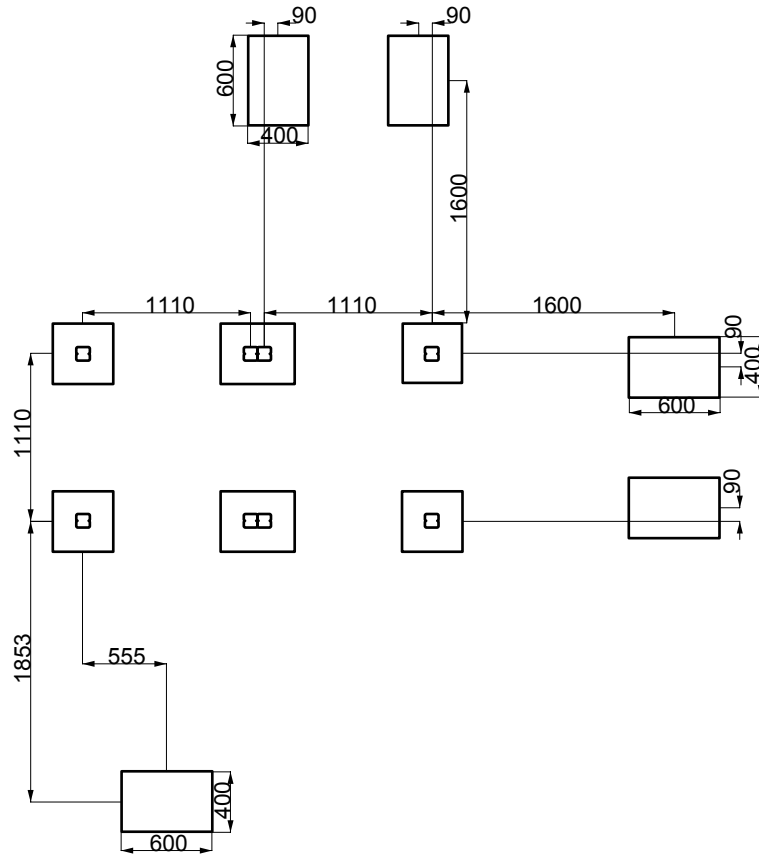

# SURFACING - OVERALL AREA

--- = MINIMUM SPACE  
— = SURFACE AREA

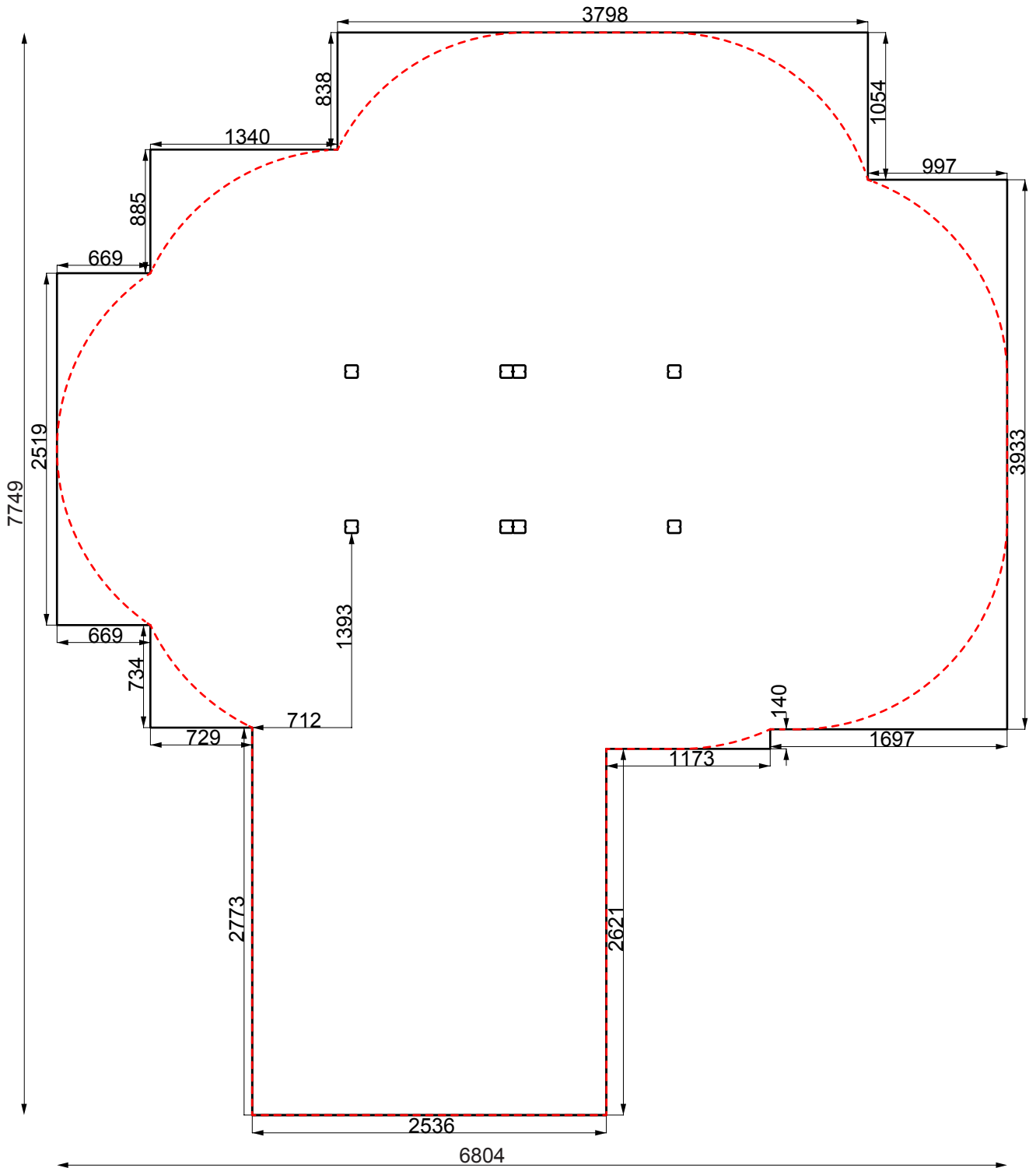

# INSTALLATION INSTRUCTIONS

**1**

**INSTALL ALL STANDARD JIGSAW PARTS AND W0109 SPECIFIC PLATFORM UNIT SHOULD LOOK LIKE THIS**

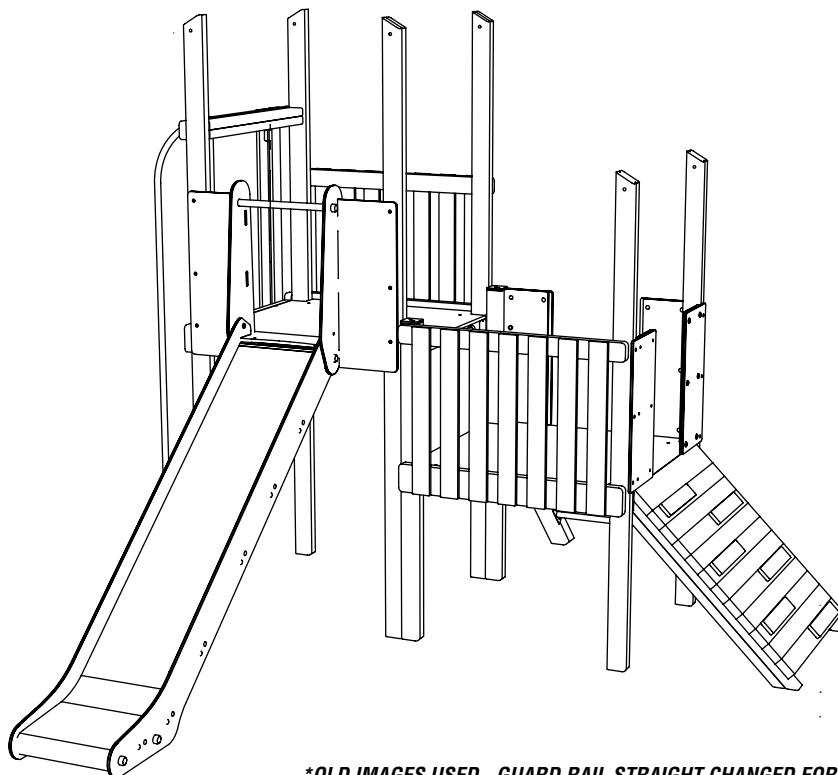

*\*OLD IMAGES USED - GUARD RAIL STRAIGHT CHANGED FOR GUARD RAIL WINDOW*

**2**

**PLEASE NOTE - END CAPS MAY NOT BE REQUIRED**  
SOME ATTACHEMENT PARTS MEAN END CAPS ARE NOT REQUIRED

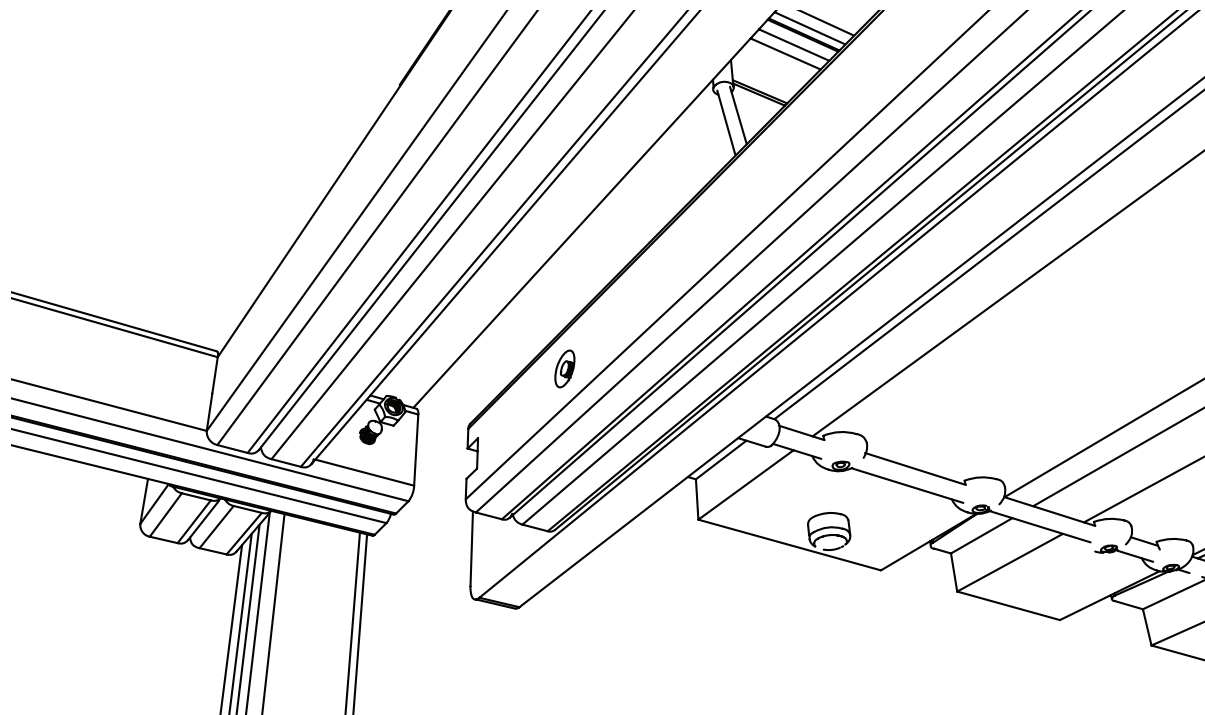

**NOTES:**  
TIMBER SUPPORT IS CUT TO FIT AROUND THE NYLOC - CIRCLED ABOVE

# INSTALLATION INSTRUCTIONS

---

**3**

## SCREW SPLIT LEVEL CLIMBER TO 1.5M PLATFORM TIMBER

USING M8X80 WOOD SCREWS

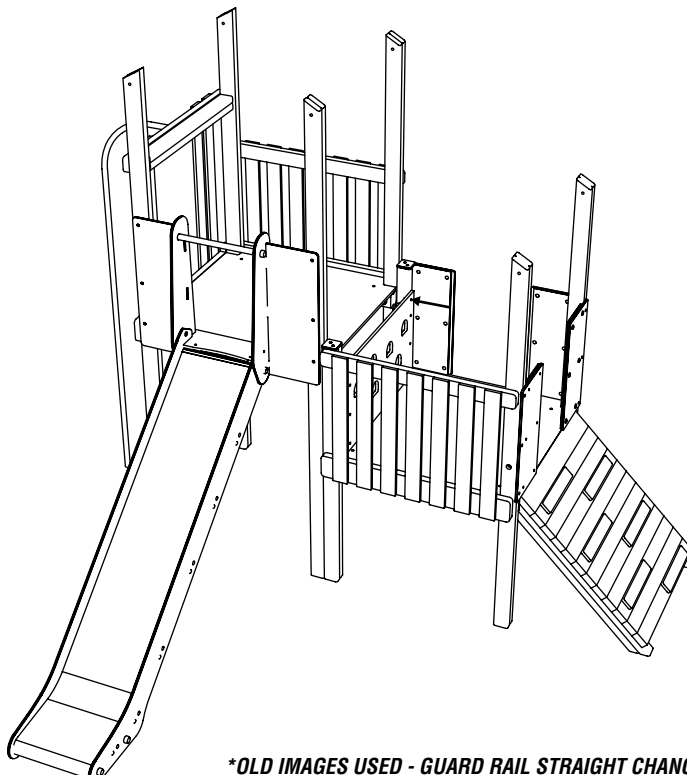

*\*OLD IMAGES USED - GUARD RAIL STRAIGHT CHANGED FOR GUARD RAIL WINDOW*

**4**

## SCREW LARGE AND SMALL ROOF SECTIONS TOGETHER

USING ROOF BRACKETS AND M8X80 WOOD SCREWS

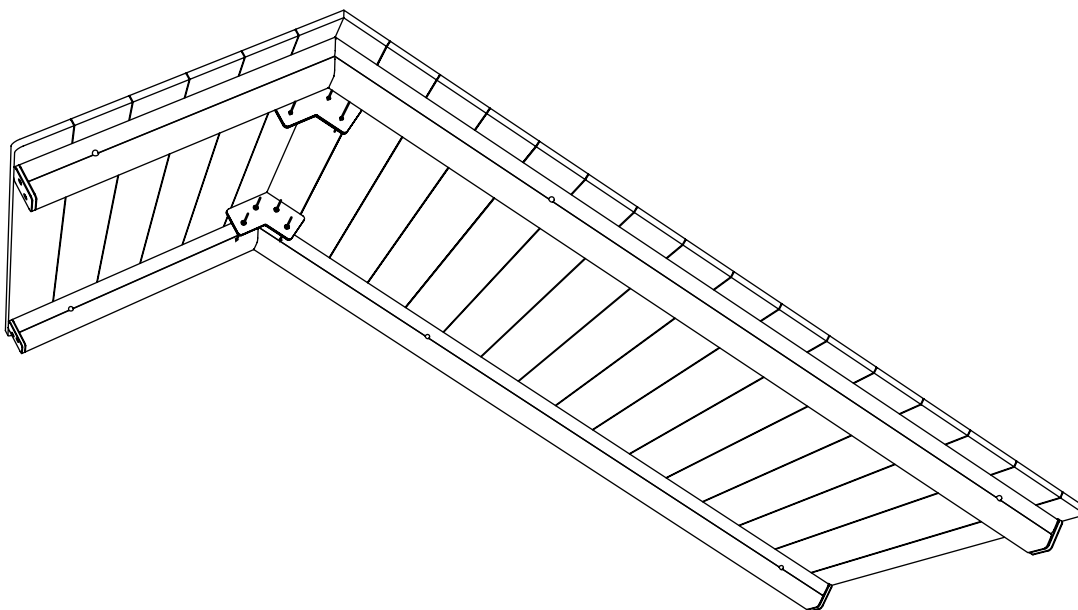

# INSTALLATION INSTRUCTIONS

## 5 POSITION ROOF SECTION IN PLACE

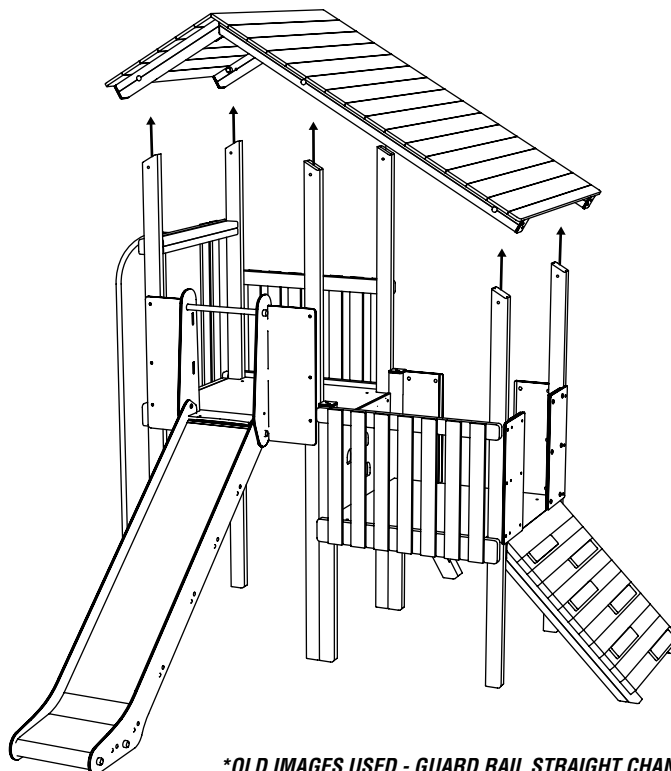

*\*OLD IMAGES USED - GUARD RAIL STRAIGHT CHANGED FOR GUARD RAIL WINDOW*

## 6 SECURE ROOF INTO PLACE USING M12X200 BOLTS, M12 NYLOCS AND COVERED ENDS

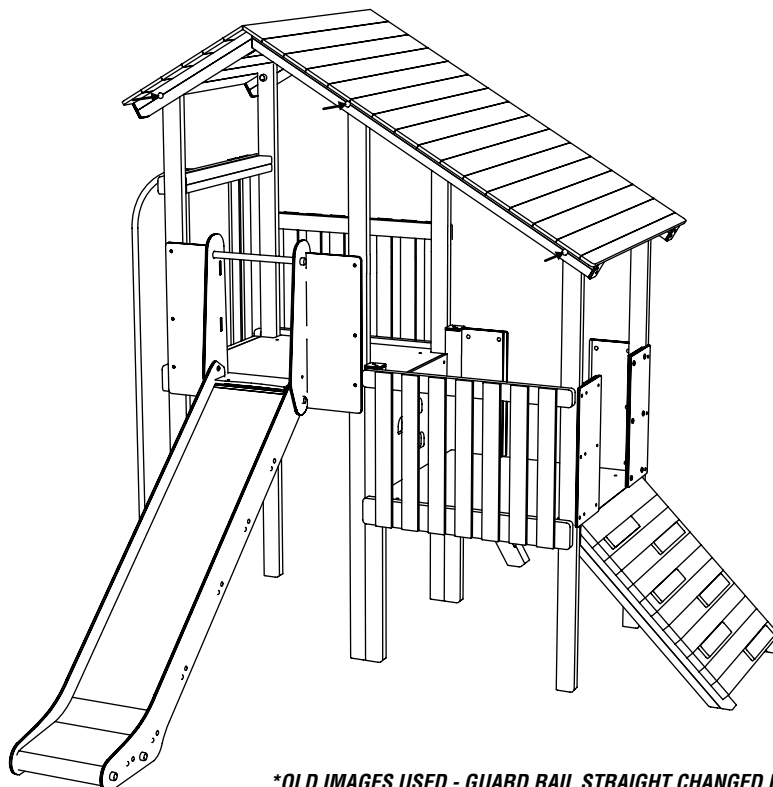

*\*OLD IMAGES USED - GUARD RAIL STRAIGHT CHANGED FOR GUARD RAIL WINDOW*



# INSTALLATION INSTRUCTIONS

---

**7**

**FIX SMALL TIMBER GUARD INTO PLACE IN LINE WITH JIG102 AND SLIDE TOPS**  
USING M8X80 SCREWS

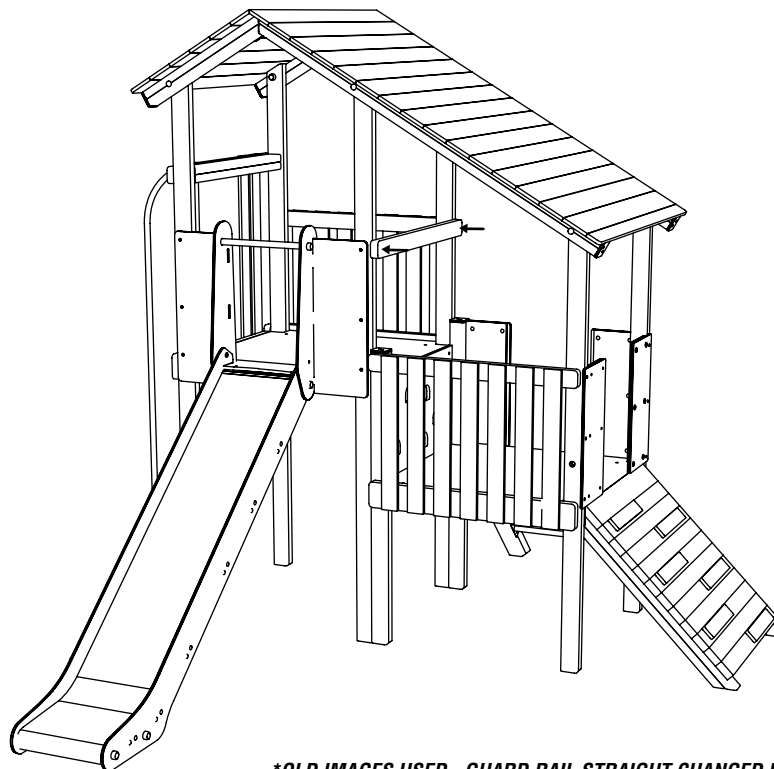

*\*OLD IMAGES USED - GUARD RAIL STRAIGHT CHANGED FOR GUARD RAIL WINDOW*

# ADDITIONAL MEASUREMENTS

*\*OLD IMAGES USED - GUARD RAIL STRAIGHT CHANGED FOR GUARD RAIL WINDOW*

