

SQUARE-SHAPED

SQUARE Modular Seating

Assembly Instructions

**creative
play**

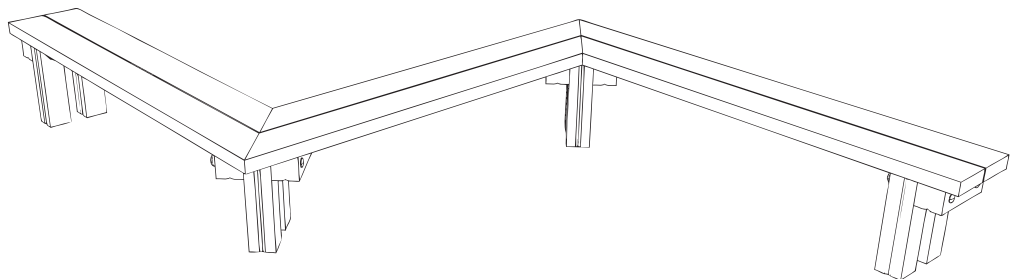
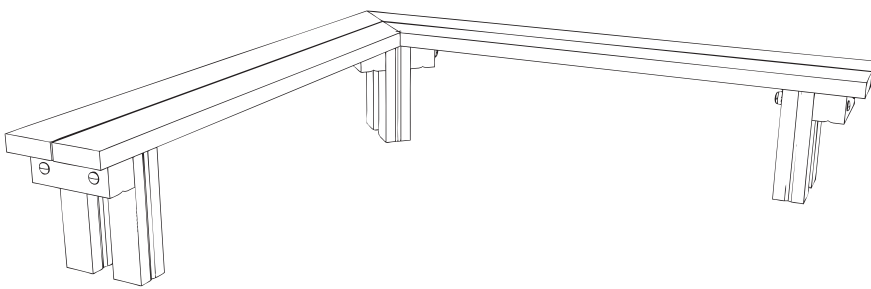
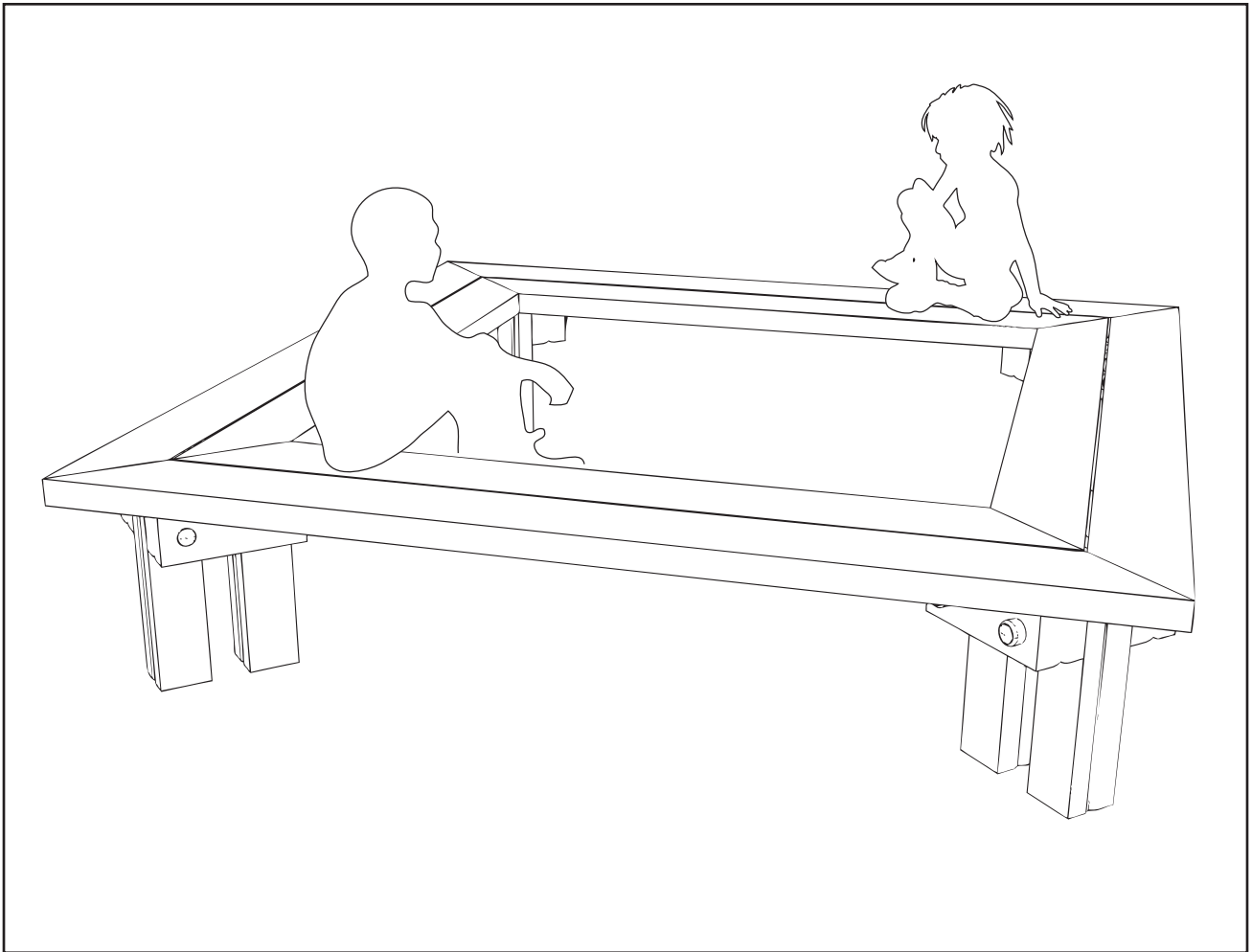

PARTS required

T3a QTY 4 (147mm x 47mm)

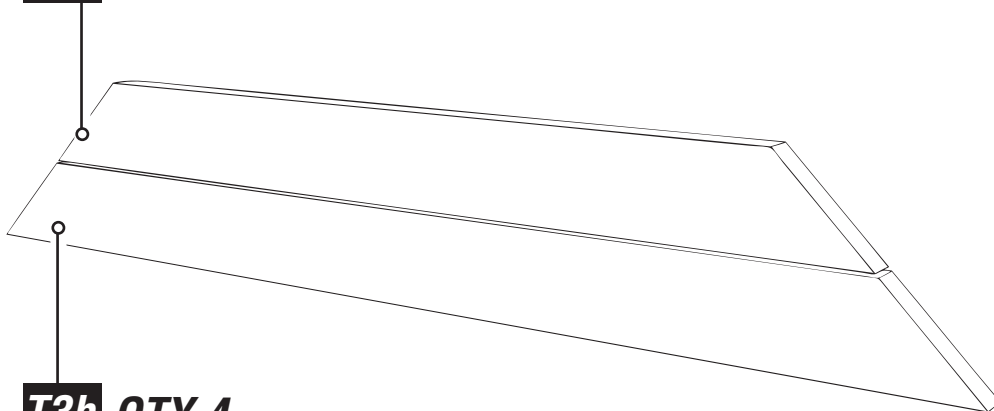

T3b QTY 4 (147mm x 47mm)

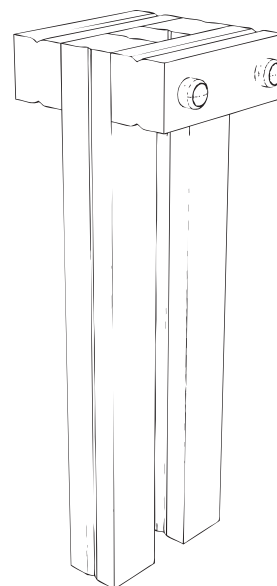

QTY 4 (double support)

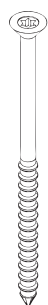

x32 (120mm brass screws)

TOOLS required

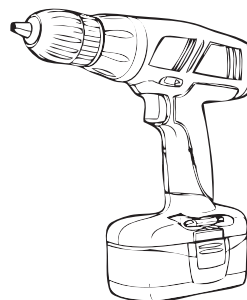
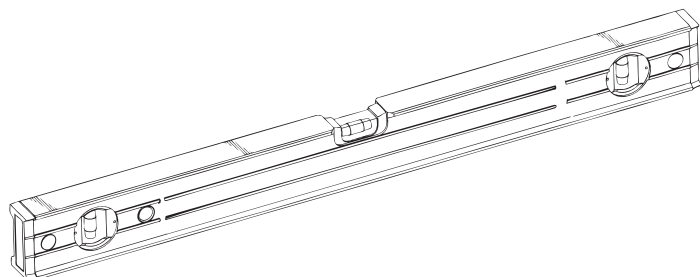

Foundation Details

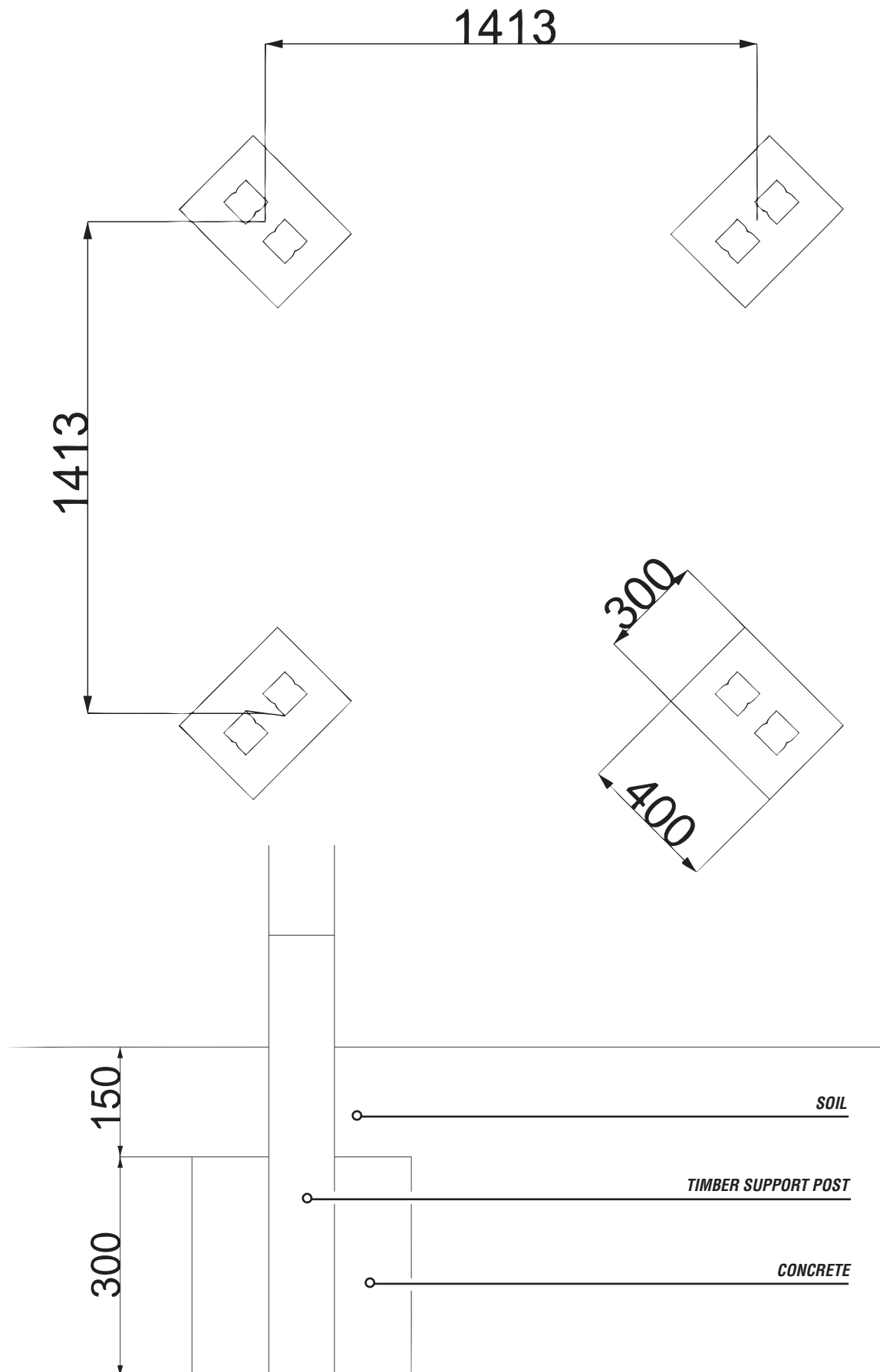

Assembly Instructions

1

If the bench IS pre-assembled follow foundation details

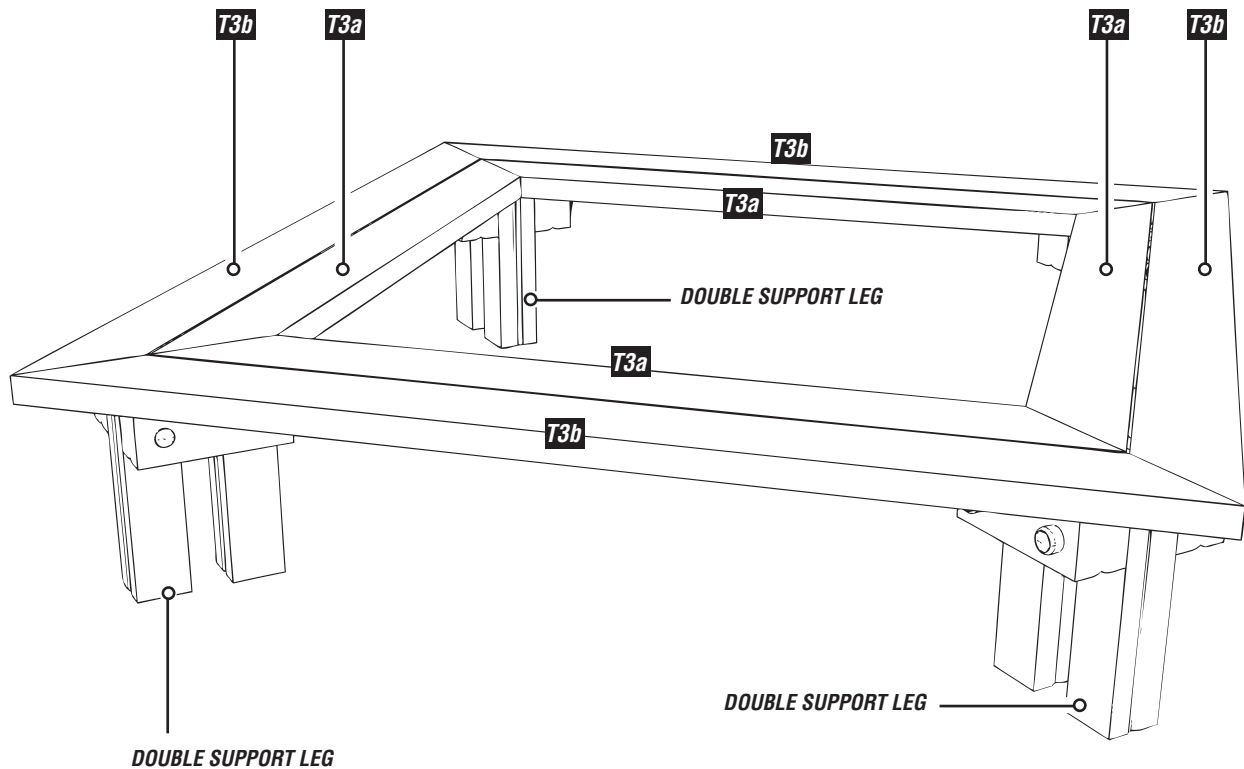

2

Attach bench slats (T3 timbers) to the support assemblies *Using 120mm brass screws*

5mm gap between T1 timber slats

POSITIONING FOR DOUBLE SUPPORT LEG

25

Assembly Instructions

3

Attach bench slats (T1 & T2 timbers) to the support assemblies *Continued....*

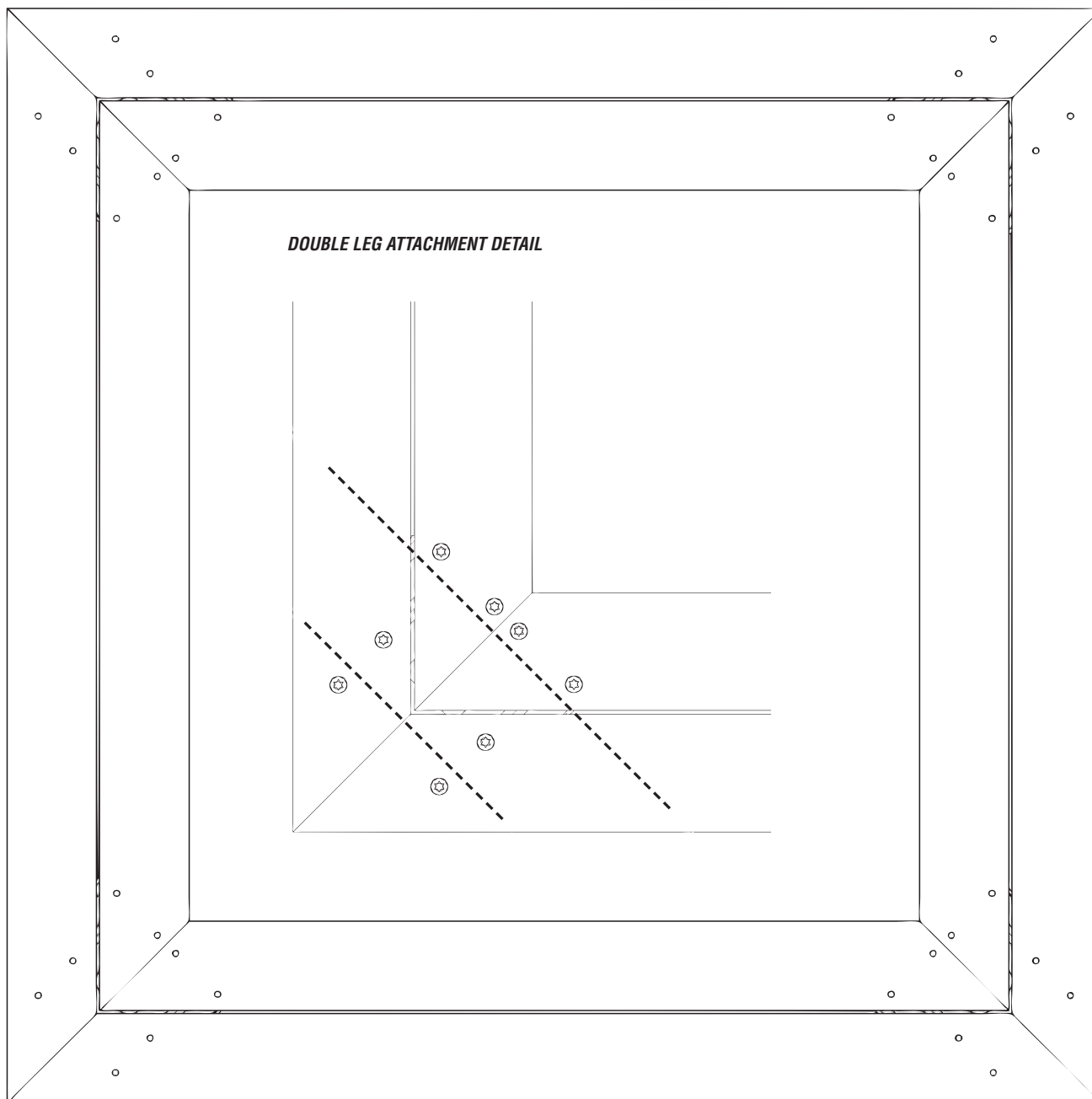

***IMPOTANT - DASHED LINE SHOWS BOLT LOCATIONS FOR BENCH SUPPORTS - ensure the screws for the SLATS are positionned either side**

4 x 120mm brass screws for each T1 /T2 timber (2 each end)

Assembly Instructions

4

Additional dimensions

