

CURVED Modular Seating Assembly Instructions

**creative
play**

5 **PIECE**

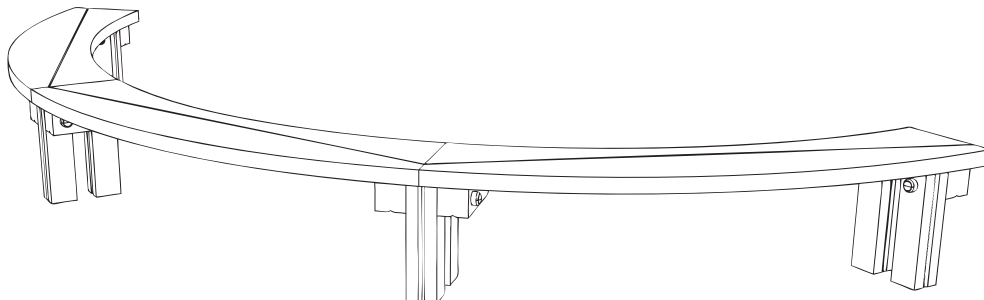
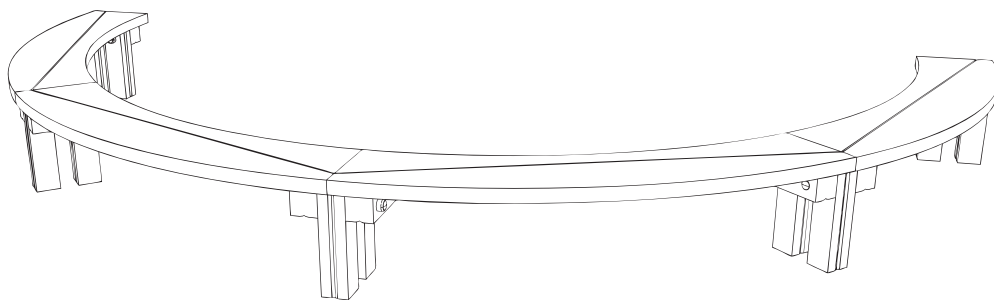
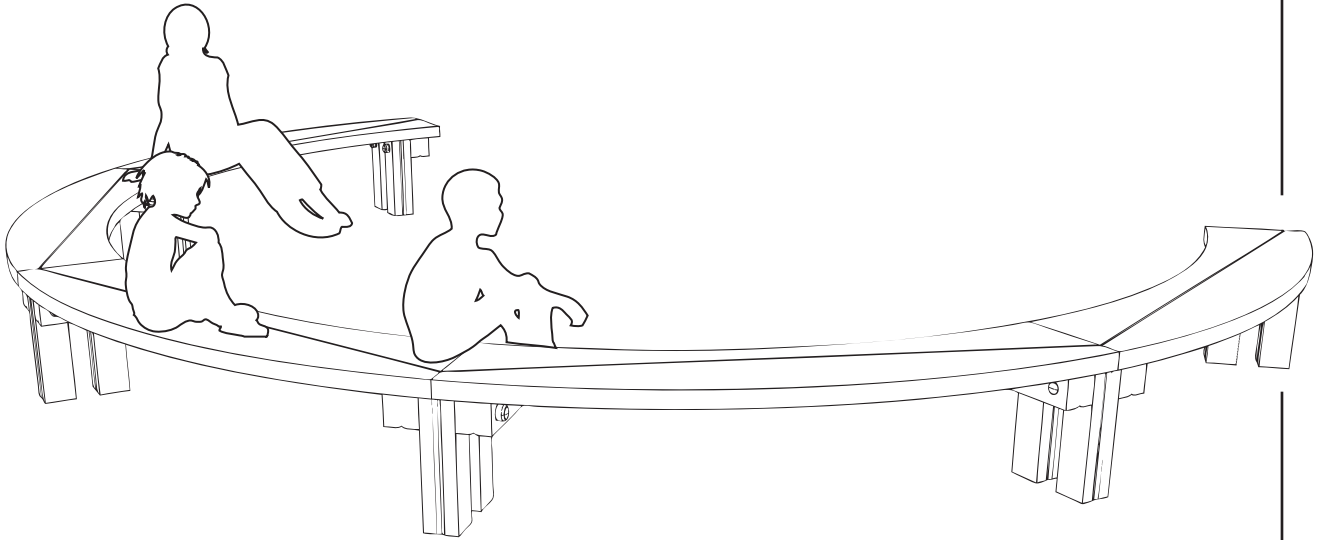

PARTS required

T1 QTY 5 (220mm x 47mm)

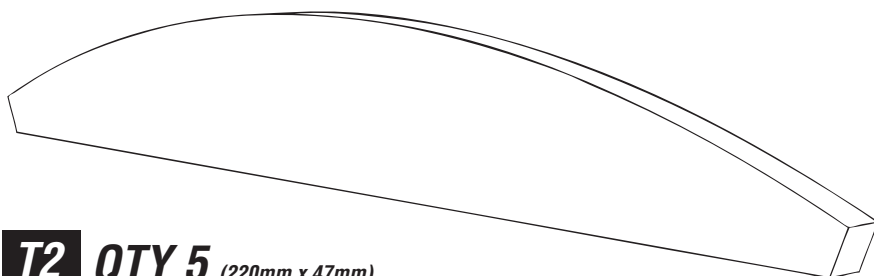

T2 QTY 5 (220mm x 47mm)

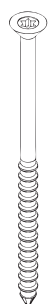
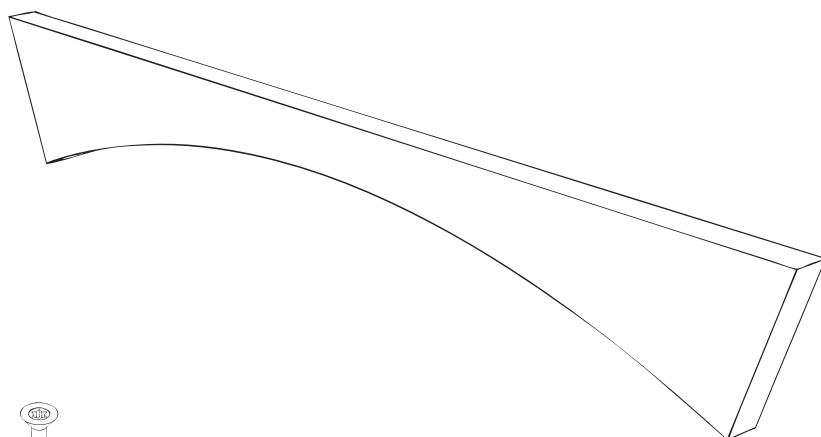

x50 (120mm brass screws)

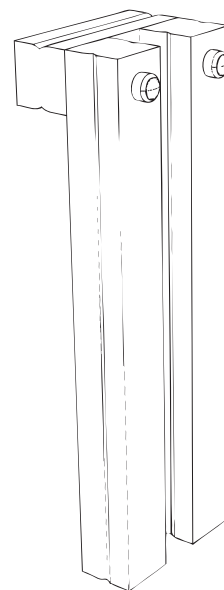

QTY 2 (single support)

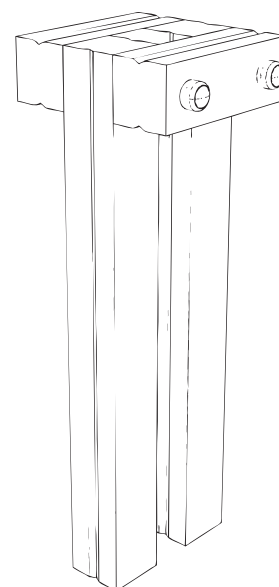

QTY 4 (double support)

TOOLS required

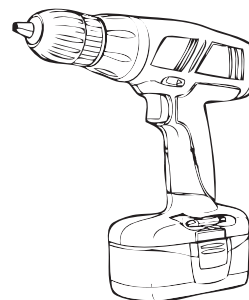
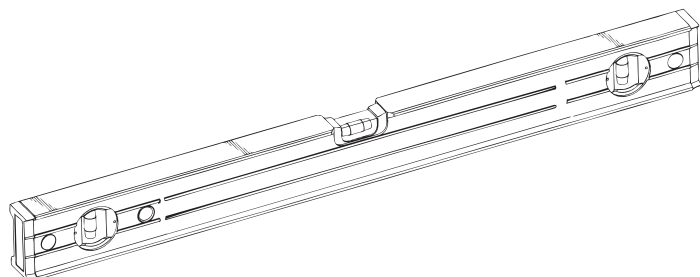

Foundation Details

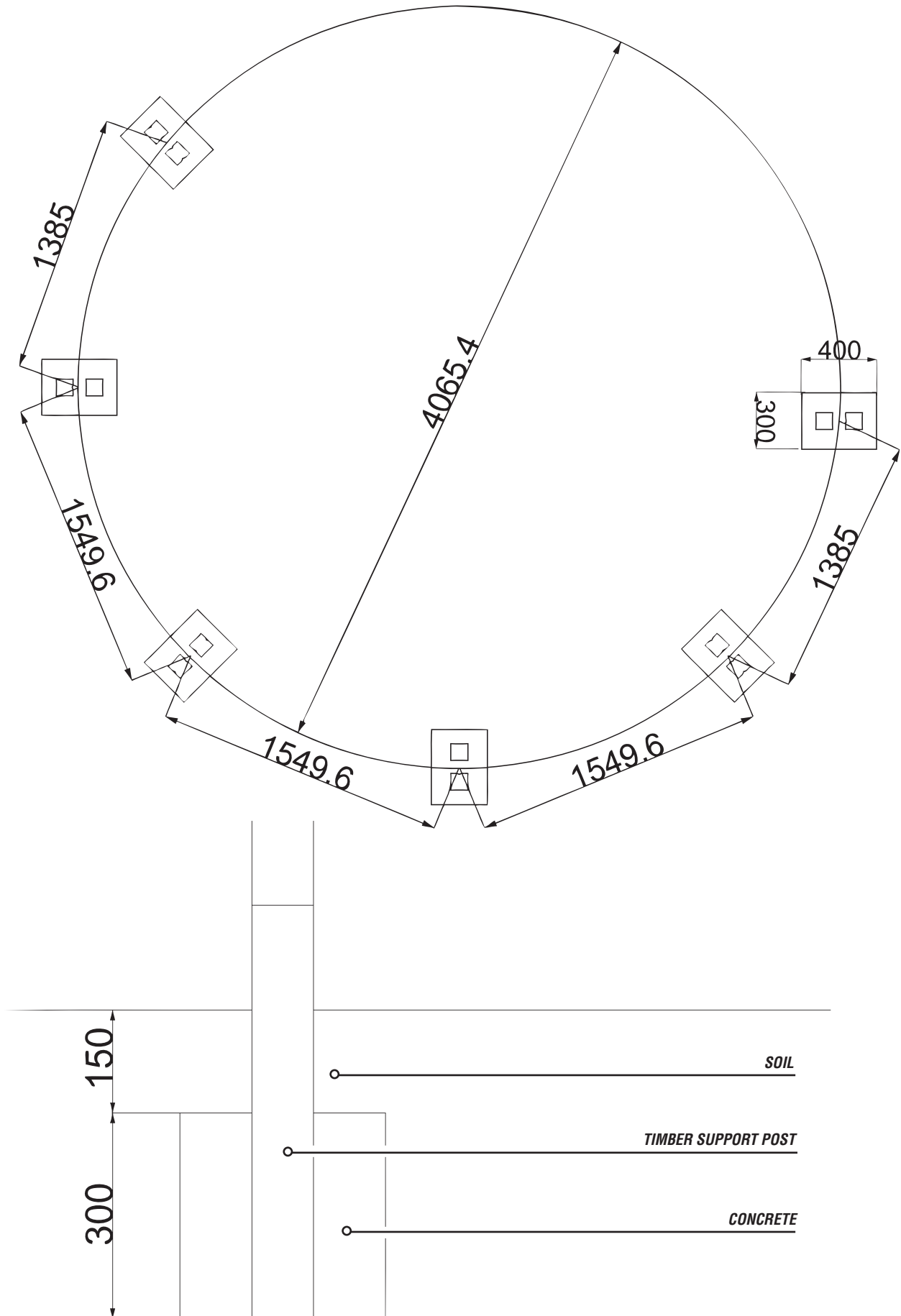

Assembly Instructions

1

5 PIECE CURVED Modular Seating

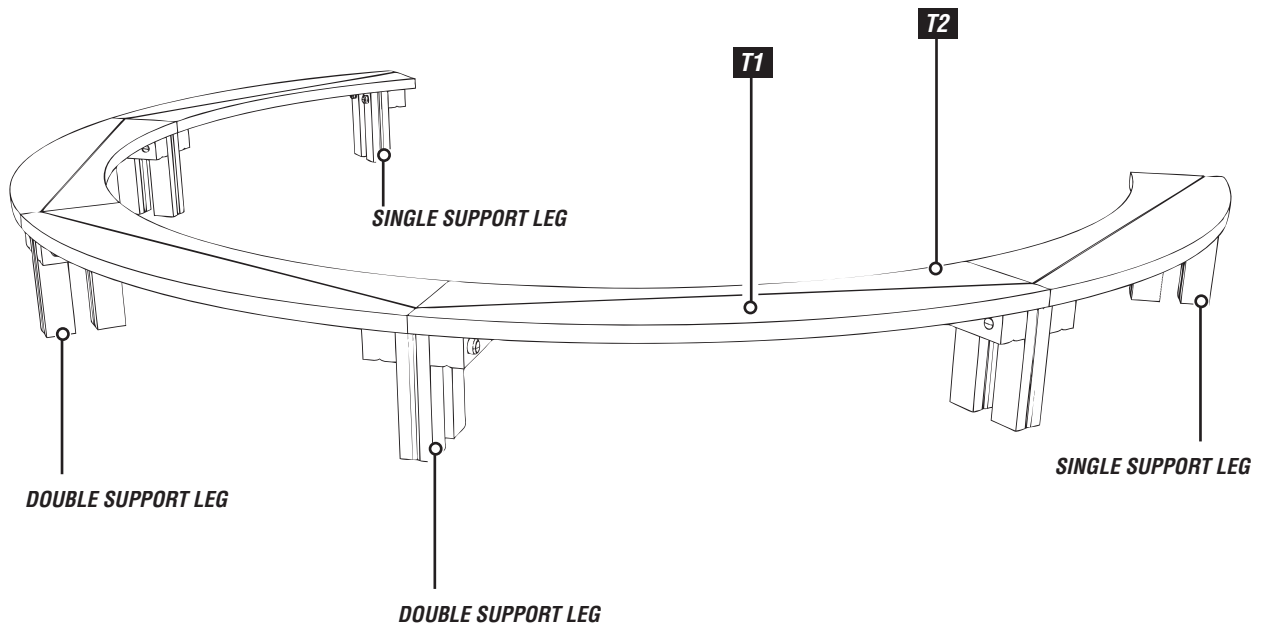

2

Attach bench slats (T1 & T2 timbers) to the support assemblies

Using 120mm brass screws

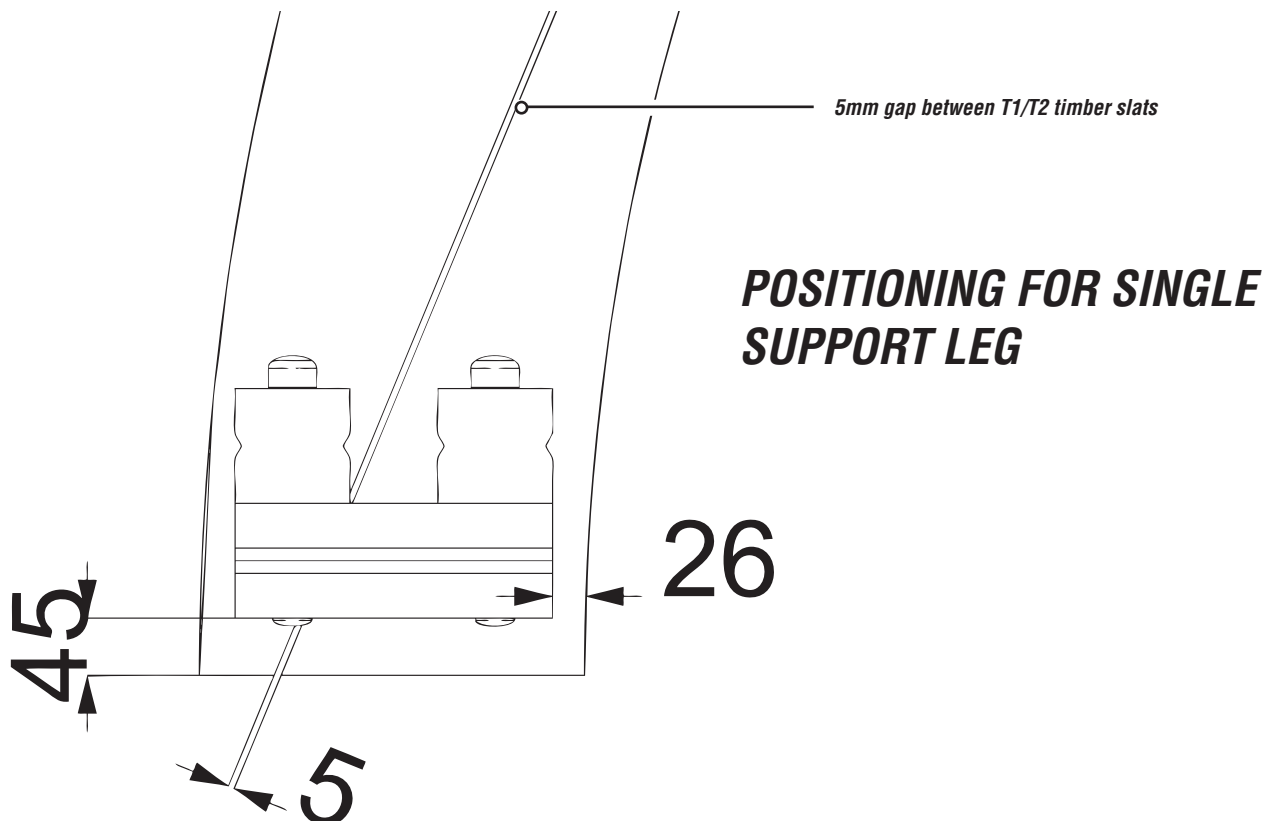

Assembly Instructions

3

Attach bench slats (T1 & T2 timbers) to the support assemblies *Continued....*

POSITIONING FOR DOUBLE SUPPORT LEG

28

5mm gap between T1 timber slats

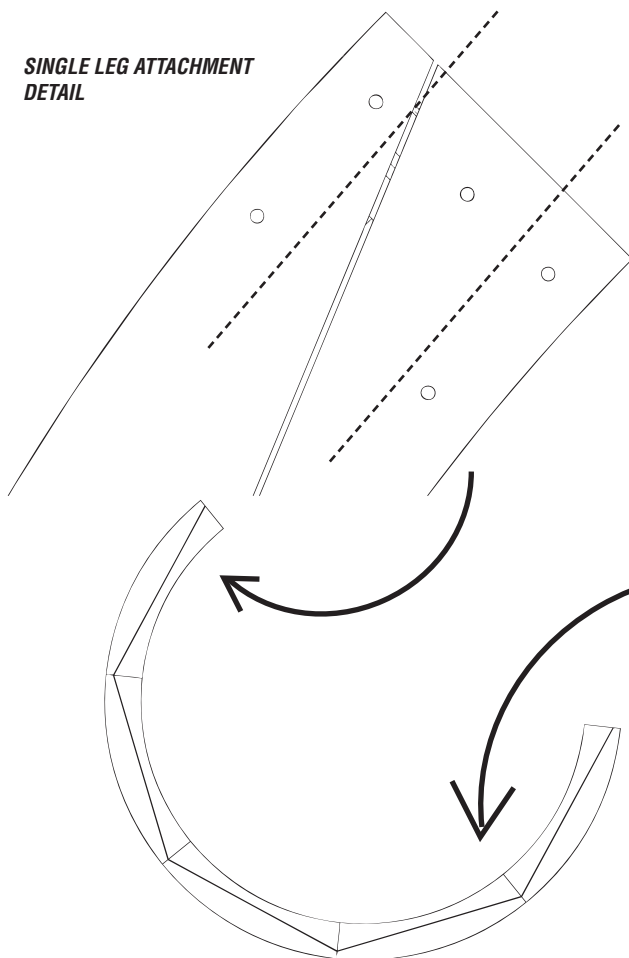

**SINGLE LEG ATTACHMENT
DETAIL**

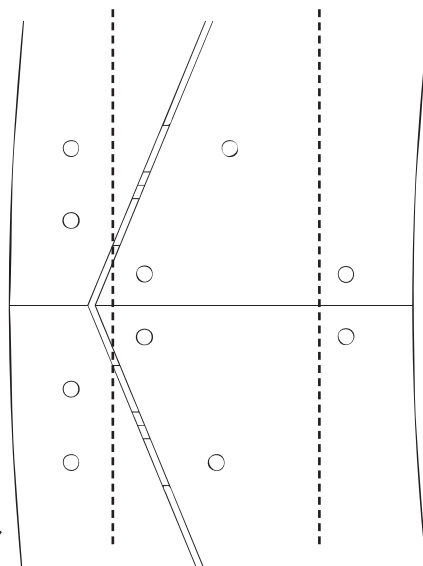

**DOUBLE LEG ATTACHMENT
DETAIL**

***IMPOTANT - DASHED LINE SHOWS
BOLT LOCATIONS FOR BENCH SUPPORTS
- ensure the screws for the SLATS are
postionned either side**

Assembly Instructions

4

Additional dimensions

